

Exodus
NKJV

Éxodo
RVR95

Exode
LSG

2 Mose
LUTH1545

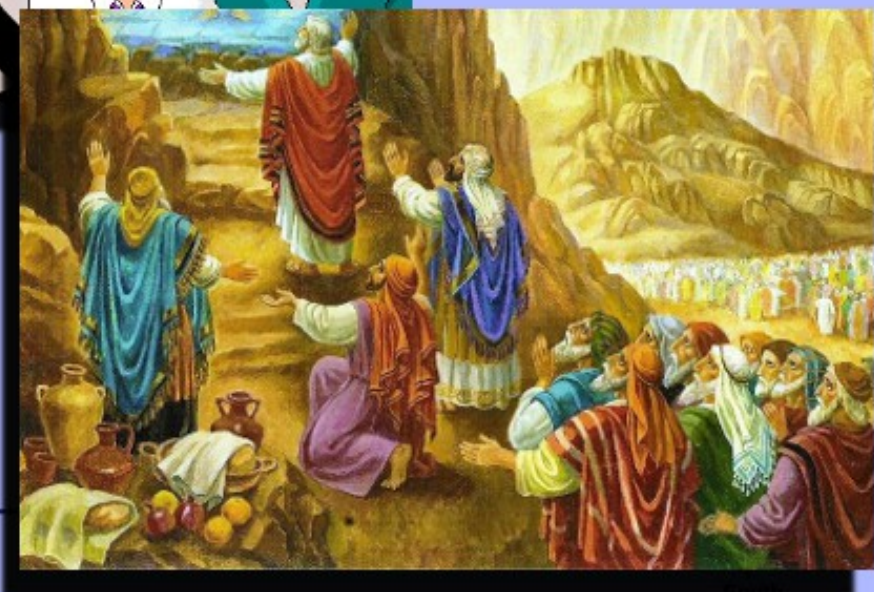
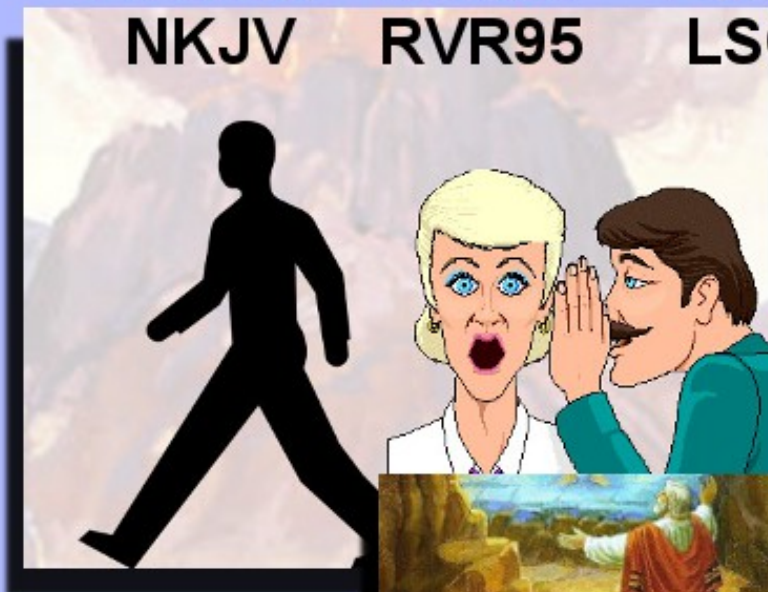

Ark of the
Covenant
 $2\frac{1}{2} \times 1\frac{1}{2} \times 1\frac{1}{2}$

Golden
Altar of
Incense
 $1 \times 1 \times 2$

Table of
Showbread
 $2 \times 1 \times 1\frac{1}{2}$

Brazen
Layer

Brazen Altar of
Bunt Offerings
 $5 \times 5 \times 3$

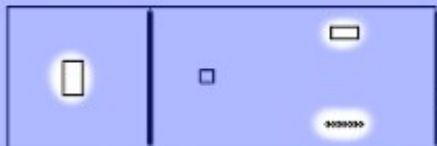

The Veil

Golden
Menorah

The Holy
of Holies
 $10 \times 10 \times 10$

The Holy
Place
 $10 \times 20 \times 10$



Gate 20 cubits

23-25

We have assembled this work to further the kingdom of Jesus Christ. It is not our intention to infringe on the copyrights of anyone, and have diligently selected picture sources and Bible translations that permit them to be duplicated and re-distributed for non-commercial, educational purposes as packaged. If you own the copyright to any of these, and believe we are making them inappropriately available, please let us know and we will immediately remove the offending components. Credit information for each picture is given at the end of this book.

Except for the contributions of others, this work is licensed under the Creative Commons Attribution-ShareAlike License. A copy of this license is available from, <http://creativecommons.org/licenses/by-sa/4.0/> or by mail from Creative Commons, 559 Nathan Abbott Way, Stanford, California 94305, USA.

Scripture taken from the following translations:

New King James Version copyright © 1982 by Thomas Nelson. Used by permission.

Reina-Valera 95 © Sociedades Biblicas Unidas, 1995. Used by permission.

Louis Segond (LSG) translation.

Luther's translation

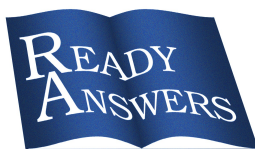

Unit EF

Exodus 19-22

Bill and Shelley Houser

Copyright © August 14, 2015

Ready Answers, William and Rochelle Houser, 2013 Old State Rt 66,

Newburgh, IN 47630, Phone: 812-858-9241.

www.ReadyAnswers.org

CONTENTS

- Forward.....page 4
- English: New King James Version.....page 9
 - Questions and Handles.....page 39
- Spanish: Reina-Valera.....page 41
- French: Louis Segond.....page 71
- German: Luther 1545page 101
- Picture sources.....page 107

Blank pages are included at the beginning and/or end of each Bible translation. These are available for you to write notes, review questions, etc. If you print these pages on colored paper, the sections will be easier to find.

Foreword

The Ready Answers Bible Memorization Program is designed to help you memorize Bible passages easily and quickly. It is based on many well-proven strategies for memorizing. Although this material is designed to help teams prepare for the Pathfinder Bible Experience Competition, beginning early 2016, we hope that others wanting to become familiar with Exodus will find this helpful.

Team Organization:

We are dividing Exodus into 12 segments. Each segment takes approximately 20 minutes to read. Since the teams consist of 6 members, each member should learn at least 2 segments. If you want some overlap, consider the following example. Each team member is assigned as the primary person responsible for 2 segments (labeled with “1”) and is assigned secondary responsibility for an additional 2 segments (labeled with “2”). If you have a particularly skilled team member, he or she can be assigned more segments as tertiary responsibility, and all members should have copies of each of the 12 segment booklets, to at least be familiar with all of the Book of Exodus. With this approach, each question will be answerable by at least 2 people. This will help if a member needs some assurance during the competition, or is unable to participate.

Segment	Team Member					
	Alex	Adam	Lexi	Jordan	Jeffrey	Noah
Chapters 1-4	1					2
Chapters 5-8	2	1				
Chapters 9-10		2	1			
Chapters 11-14			2	1		
Chapters 15-18				2	1	
Chapters 19-22					2	1
Chapters 23-25	1					2
Chapters 26-28	2	1				
Chapters 29-31		2	1			
Chapters 32-34			2	1		
Chapters 35-37				2	1	
Chapters 38-40					2	1

The Memorization Method:

By using visual, auditory, and body-motion (kinetic) memory aids, which we call “handles”, you can get information to stick in your short-term memory. By reviewing the information on a regular basis, you can get the information to transfer to your long-term memory.

Steps:

1. Preview
2. Learn
3. Review

Step 1: Preview:

In this step, we recommend that you take a week or two to read through the segment book, at least once per day, and preferably in one sitting. This will help get the entire section into your mind as a large chunk. Try reading it out loud, so you can hear the words. Try reading it (or listening to it) while

walking around, or doing some type of motion, like an exercise bike, etc. Different approaches work better for different people. In this preview step, it is best to look at the pictures, and decide where to focus for each phrase of the verses. These will become your handles to learn the verses later. You may also find it helpful to think of some rhyming words, or body motions that seem to go with the phrases, or ways to remember the sequences of verses. However, during this step, you should mainly focus on just getting familiar with the material you are going to learn.

Step 2: Learn

In this step, take each verse, and break it into phrases that are about 3-5 words long. As you get better at memorizing, these phrases can get longer and longer, (our record is about 18 words), but for the first few chapters, keep them short. Then, take a part of the picture, and find something in it to associate with each phrase. Look and point to the picture while you say the first phrase 3 times. When you can say the first phrase perfectly, then start to learn the next phrase. Look and point to a different part of the picture that you are going to associate with the second phrase, and say the second phrase 3 times. When you can say the second phrase perfectly, then say the first and second phrases together, looking at the first part of the picture for the first phrase, and then the second part of the picture for the second phrase. If you are having difficulty joining the phrases together, then practice just the few words at the end of the first phrase, and the first few words of the second phrase together at least three times. Continue on in this manner, until you have learned each phrase in the verse, and tied them together in your mind.

Be creative in making and using handles. The more outrageous the handle, the more likely you will be able to remember it. It does not need to “make sense”, or be grammatically correct, etc. It just needs to help you remember the Bible verse.

So, for example, see the silly story for remembering the order of the names of the children of Israel that came into Egypt for Exodus 1:1-4, and the other silly baseball story for remembering the names of the inhabitants of the land of Caanan that God would drive out, in Exodus 3:8 and 3:17. These are located in the Chapter Questions and Handles section later on in the book.

For using the picture, an example would be for Exodus 1:6 “And Joseph died, all his brothers, and all that generation.”

Break the verse into phrases at the commas, since these are about 3-5 words per phrase.

For the phrase, “And Joseph died”, look at Joseph sitting on the throne.

For the phrase, “all his brothers”, look at the three brothers along the back of the room.

For the phrase, “and all that generation,” sweep your eyes over the whole set of people in a circular motion.

Or, if you prefer to sweep your eyes over all the brothers, for the phrase “all his brothers,” then for the phrase “and all that generation.”, look at the other building which is outside the room, and think about all the other people of that generation that would be living in that building over there.

Whatever you choose to use, be sure you use it consistently as you are trying to learn the verse.

We have tried to put something in each picture that can be used as a natural handle for at least one of the phrases. When we have used the same picture multiple times, there is something different about it to distinguish the two different passages. Generally, if God is talking to Moses, telling him what is going to happen, we have used the picture of it happening, with either the burning bush, or a set of rays of light around the picture. Then, when it is actually happening, the picture is used by itself.

The other times we are using the same picture is during conversations with Pharoah and Moses. When Pharoah is speaking, there will be a highlight or focus more on Pharoah, and when Moses is speaking, there will be a highlight or focus more on Moses. Generally, for each conversation, there is a different picture. For most of the conversations, there is only one “back and forth” interaction between Moses and Pharoah. However, sometimes, they answer back and forth more than once in the same encounter. We have used a separate picture for each “back and forth”, to make it easier to remember. So don't rely on picture scene changes only to distinguish different encounters between Moses and Pharoah. Try to set aside a few minutes each day to learn a new verse, and review some of the older verses.

Step 3: Review

We have found that the newly learned verses need more review than verses that you have learned well a little earlier. It seems to work very well to have a Fibonnacci-type review on the verses you learned. For a full discussion on the learning and review process, please download our Teacher's Guide from our website, [http\\www.ReadyAnswers.org](http://www.ReadyAnswers.org).

It is our hope and prayers that you can use this to aid in your learning of the Book of Exodus.

Blessings,
Bill and Shelley Houser



Unit EG

Exodus 23-25

Bill and Shelley Houser
<http://www.ReadyAnswers.org>

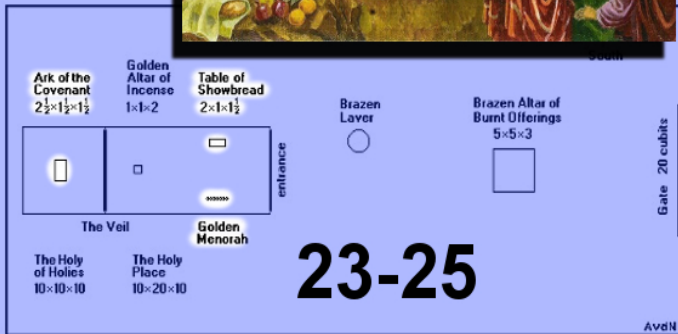

Scripture taken from the New King James Version copyright © 1982 by Thomas Nelson. Used by permission.

1



Justice for All

Chapter 23: ¹“You shall not circulate a false report.
Exodus 23: 1a

Do not put your hand with the wicked to be an unrighteous witness.
Exodus 23: 1b



²You shall not follow a crowd to do evil; Exodus 23:2a

nor shall you testify in a dispute so as to turn aside after many to pervert justice. Exodus 23:2b

4

5



³You shall not show partiality to a poor man in his dispute. Exodus 23:3

⁴“If you meet your enemy’s ox or his donkey going astray, you shall surely bring it back to him again. Exodus 23:4

6

7



⁵If you see the donkey of one who hates you lying under its burden, and you would refrain from helping it, you shall surely help him with it. Exodus 23 : 5

8



⁶“You shall not pervert the judgment of your poor in his dispute. Exodus 23 : 6

9



⁷Keep yourself far from a false matter; do not kill the innocent and righteous. For I will not justify the wicked. Exodus 23 : 7

10



⁸And you shall take no bribe, for a bribe blinds the discerning and perverts the words of the righteous. Exodus 23 : 8

11



The Law of Sabbaths

⁹ “Also you shall not oppress a stranger, for you know the heart of a stranger, because you were strangers in the land of Egypt. Exodus 23 : 9

12

¹⁰ “Six years you shall sow your land and gather in its produce, Exodus 23 : 10

13

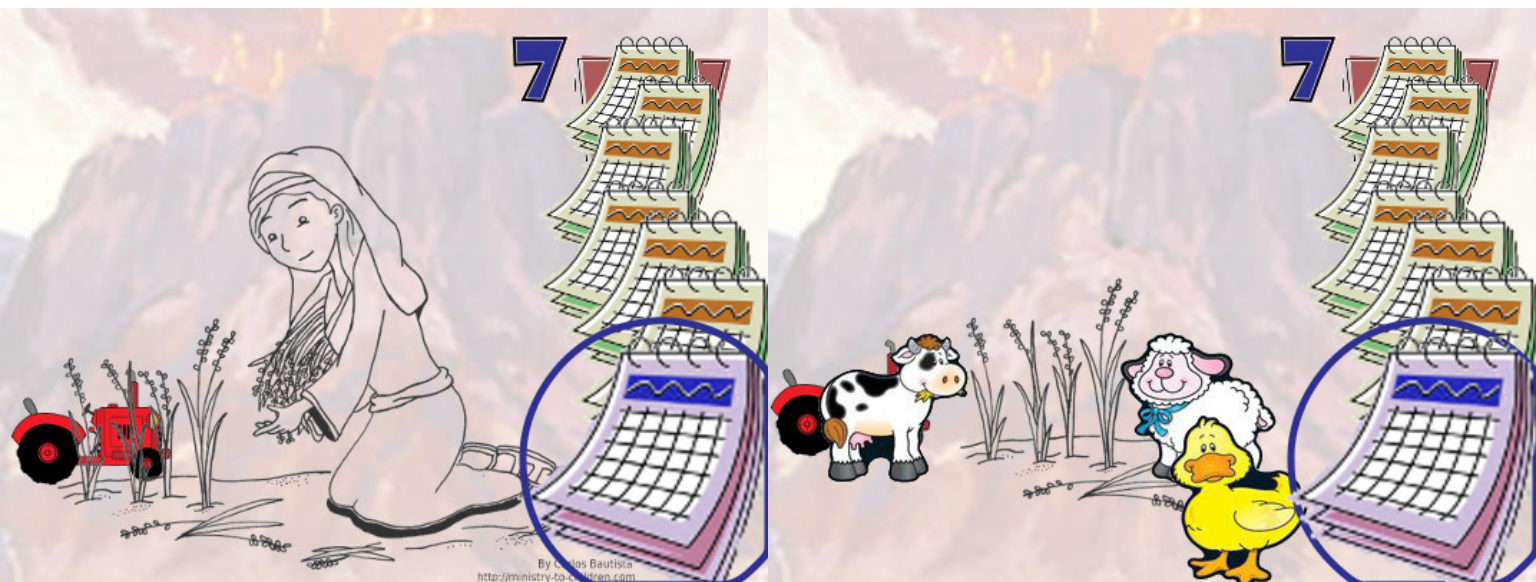

¹¹ but the seventh year you shall let it rest and lie fallow, that the poor of your people may eat; Exodus 23 : 11a

14

and what they leave, the beasts of the field may eat. Exodus 23 : 11b

15

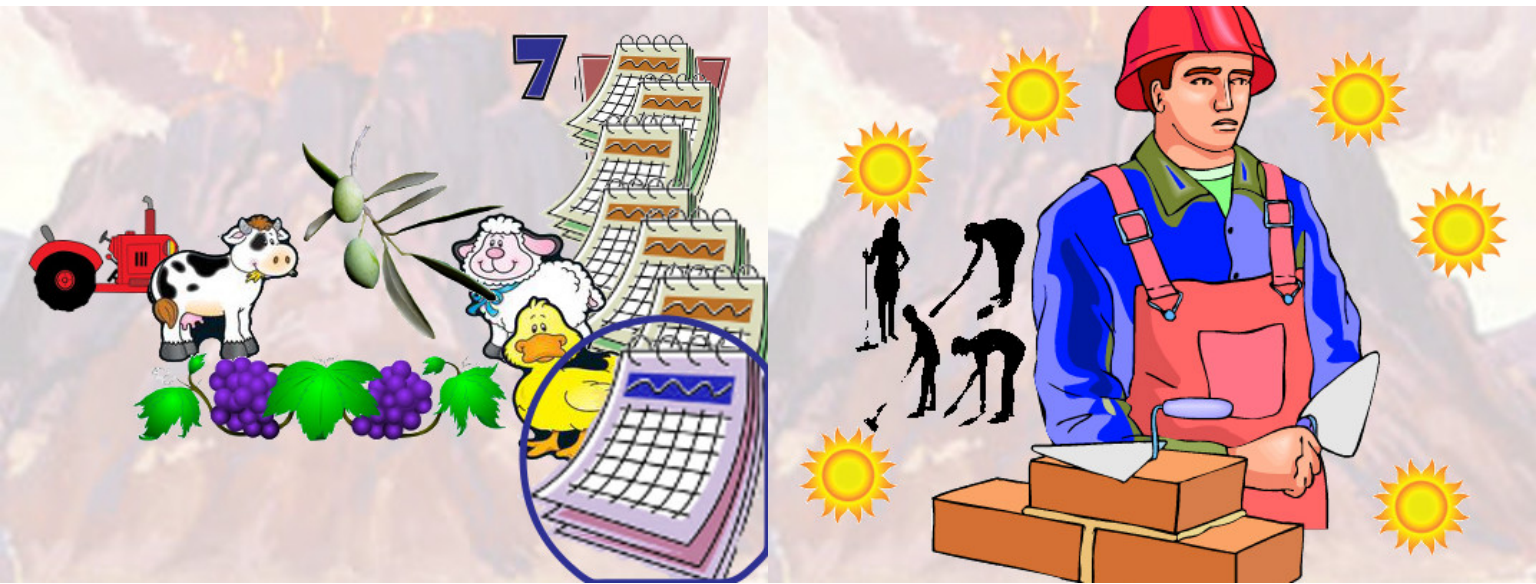

In like manner you shall do with your vineyard and your olive grove.
Exodus 23 : 11c

¹²Six days you shall do your work,
Exodus 23 : 12a

16

17

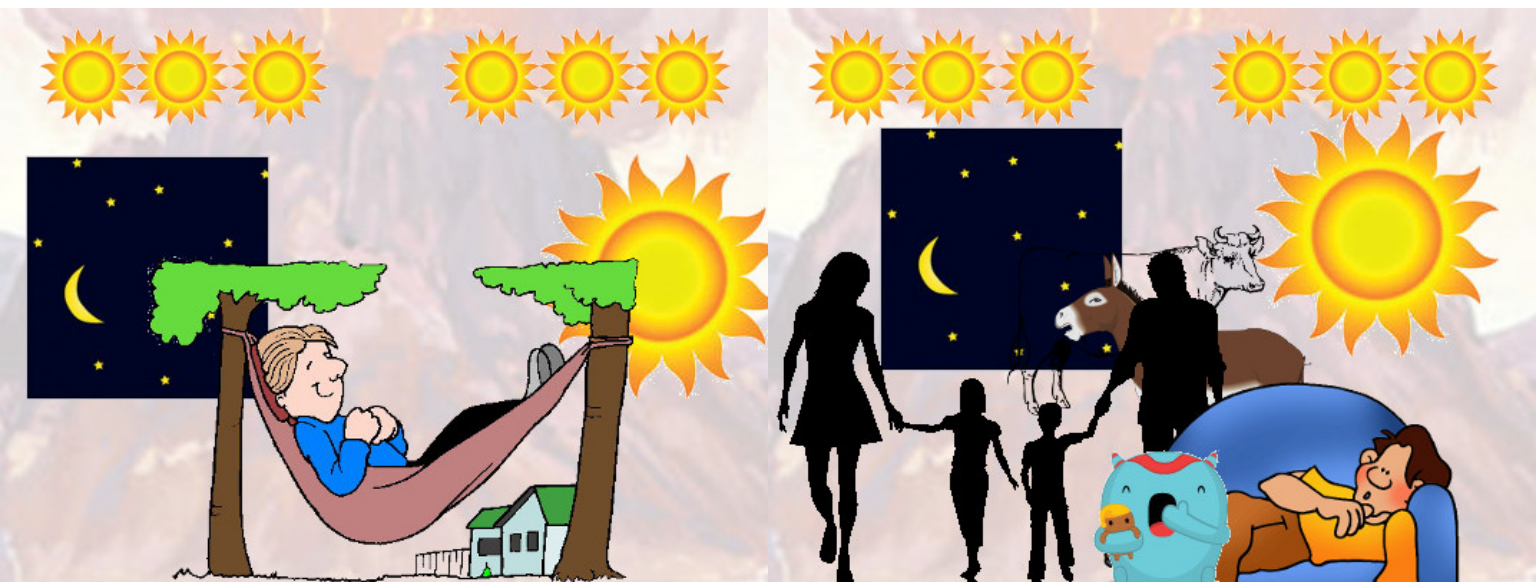

and on the seventh day you shall rest,
Exodus 23 : 12b

that your ox and your donkey may rest, and the son of your female servant and the stranger may be refreshed.
Exodus 23 : 12c

18

19



Three Annual Feasts

¹³ “And in all that I have said to you, be circumspect and make no mention of the name of other gods, nor let it be heard from your mouth. Exodus 23 : 13

¹⁴ “Three times you shall keep a feast to Me in the year: Exodus 23 : 14



¹⁵ You shall keep the Feast of Unleavened Bread (you shall eat unleavened bread seven days, as I commanded you, at the time appointed in the month of Abib, for in it you came out of Egypt; none shall appear before Me empty) Exodus 23 : 15

¹⁶ and the Feast of Harvest, the firstfruits of your labors which you have sown in the field; Exodus 23 : 16a



and the Feast of Ingathering at the end of the year, when you have gathered in the fruit of your labors from the field.
Exodus 23:16b

17 "Three times in the year all your males shall appear before the Lord GOD.
Exodus 23:17

24

25



18 "You shall not offer the blood of My sacrifice with leavened bread;
Exodus 23:18a

nor shall the fat of My sacrifice remain until morning.
Exodus 23:18b

26

27



¹⁹The first of the firstfruits of your land you shall bring into the house of the LORD your God. Exodus 23: 19a

You shall not boil a young goat in its mother's milk. Exodus 23: 19b

28

29



The Angel and the Promises

²⁰“Behold, I send an Angel before you to keep you in the way and to bring you into the place which I have prepared. Exodus 23: 20

²¹ Beware of Him and obey His voice; Exodus 23: 21a

30

31



do not provoke Him, for He will not pardon your transgressions; for My name is in Him.

Exodus 23:21b

32

²² But if you indeed obey His voice and do all that I speak, Exodus 23:22a

33



then I will be an enemy to your enemies and an adversary to your adversaries.

Exodus 23:22b

34

²³ For My Angel will go before you and bring you in to the Amorites and the Hittites and the Perizzites and the Canaanites and the Hivites and the Jebusites; and I will cut them off. Exodus 23:23

35

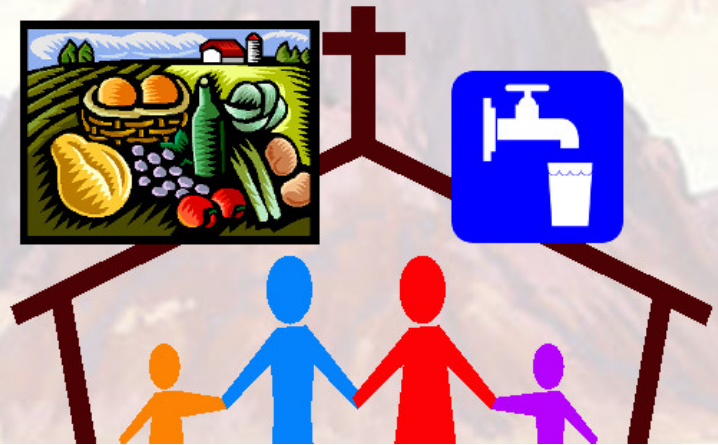

24 You shall not bow down to their gods, nor serve them, nor do according to their works; but you shall utterly overthrow them and completely break down their sacred pillars.
Exodus 23 : 24

25 "So you shall serve the LORD your God, and He will bless your bread and your water."
Exodus 23 : 25a

36

37

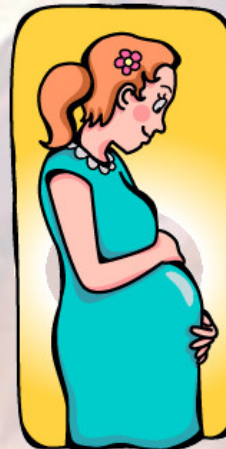

Deuteronomy 7:13-14 mention animals, too

And I will take sickness away from the midst of you.
Exodus 23 : 25b

26 No one shall suffer miscarriage or be barren in your land;
Exodus 23 : 26a

38

39



Rahab Told Spies Her People Were Afraid of the Israelites

I will fulfill the number of your days. Exodus 23 : 26b

27 "I will send My fear before you, I will cause confusion among all the people to whom you come, and will make all your enemies turn their backs to you. Exodus 23 : 27



28 And I will send hornets before you, which shall drive out the Hivite, the Canaanite, and the Hittite from before you. Exodus 23 : 28

29 I will not drive them out from before you in one year, lest the land become desolate and the beasts of the field become too numerous for you. Exodus 23 : 29



³⁰ Little by little I will drive them out from before you, until you have increased, and you inherit the land.
Exodus 23:30

44

³¹ And I will set your bounds from the Red Sea to the sea, Philistia, and from the desert to the River. For I will deliver the inhabitants of the land into your hand, and you shall drive them out before you.
Exodus 23:31

45



³² You shall make no covenant with them, nor with their gods.
Exodus 23:32

46

³³ They shall not dwell in your land, lest they make you sin against Me. For if you serve their gods, it will surely be a snare to you.”
Exodus 23:33

47



Picture used with permission: (c)2006 www.TheGloryStory.com

Israel Affirms the Covenant

Chapter 24:¹Now He said to Moses, “Come up to the LORD, you and Aaron, Nadab and Abihu, and seventy of the elders of Israel, and worship from afar.

Exodus 24 : 1

²And Moses alone shall come near the LORD, but they shall not come near; nor shall the people go up with him.”

Exodus 24 : 2

48

49



³So Moses came and told the people all the words of the LORD and all the judgments.

Exodus 24 : 3a

And all the people answered with one voice and said, “All the words which the LORD has said we will do.”

Exodus 24 : 3b

50

51

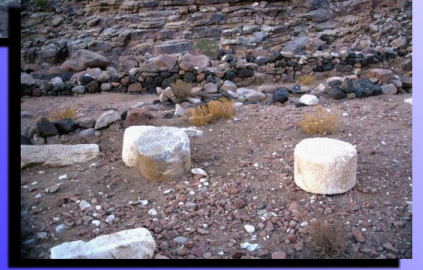

⁴And Moses wrote all the words of the LORD.
Exodus 24 : 4a

And he rose early in the morning, and built an altar at the foot of the mountain, and twelve pillars according to the twelve tribes of Israel.
Exodus 24 : 4b

52

53



⁵Then he sent young men of the children of Israel, who offered burnt offerings and sacrificed peace offerings of oxen to the LORD.
Exodus 24 : 5

⁶And Moses took half the blood and put it in basins, and half the blood he sprinkled on the altar.
Exodus 24 : 6

54

55



⁷ Then he took the Book of the Covenant and read in the hearing of the people.
Exodus 24:7a

And they said, "All that the LORD has said we will do, and be obedient."
Exodus 24:7b

56

57



On the Mountain with God

⁸ And Moses took the blood, sprinkled it on the people, and said, "This is the blood of the covenant which the LORD has made with you according to all these words."
Exodus 24:8

⁹ Then Moses went up, also Aaron, Nadab, and Abihu, and seventy of the elders of Israel,¹⁰ and they saw the God of Israel.
Exodus 24:9-10a

58

59



And there was under His feet as it were a paved work of sapphire stone, and it was like the very heavens in its clarity.
Exodus 24 : 10b

¹¹ But on the nobles of the children of Israel He did not lay His hand. So they saw God, and they ate and drank.
Exodus 24 : 11

60

61



¹² Then the LORD said to Moses, "Come up to Me on the mountain and be there; and I will give you tablets of stone, and the law and commandments which I have written, that you may teach them."
Exodus 24 : 12



¹³ So Moses arose with his assistant Joshua, and Moses went up to the mountain of God.
Exodus 24 : 13

62

63

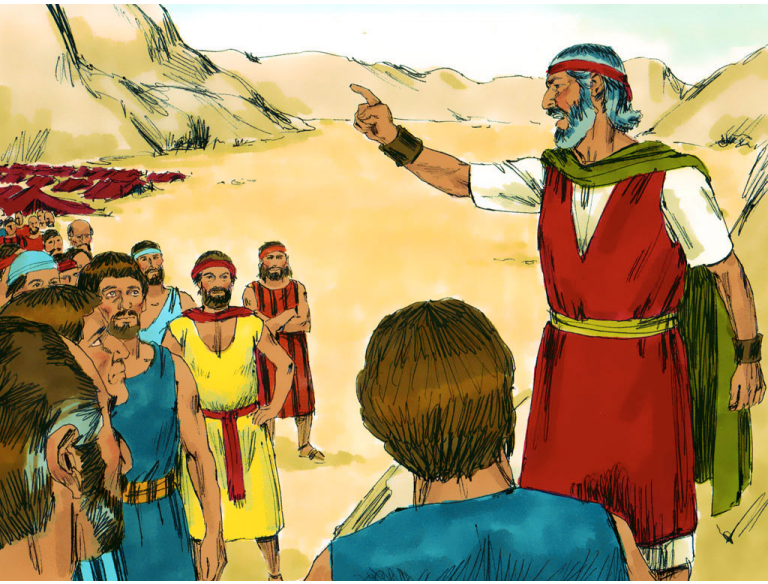

Picture used with permission: (c)2006 www.TheGloryStory.com

¹⁴ And he said to the elders, “Wait here for us until we come back to you. Indeed, Aaron and Hur are with you. If any man has a difficulty, let him go to them.”

Exodus 24 : 14

64

¹⁵ Then Moses went up into the mountain, and a cloud covered the mountain.

Exodus 24 : 15

65

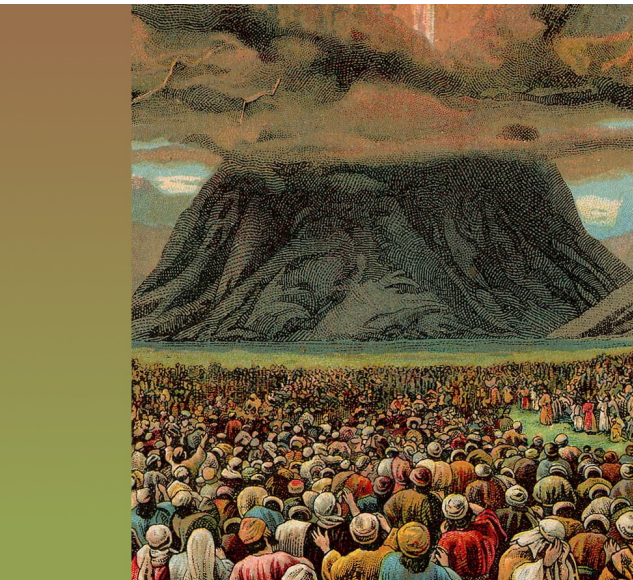

Picture used with permission: (c)2006 www.TheGloryStory.com

¹⁶ Now the glory of the LORD rested on Mount Sinai, and the cloud covered it six days. And on the seventh day He called to Moses out of the midst of the cloud.

Exodus 24 : 16

66

¹⁷ The sight of the glory of the LORD was like a consuming fire on the top of the mountain in the eyes of the children of Israel.

Exodus 24 : 17

67

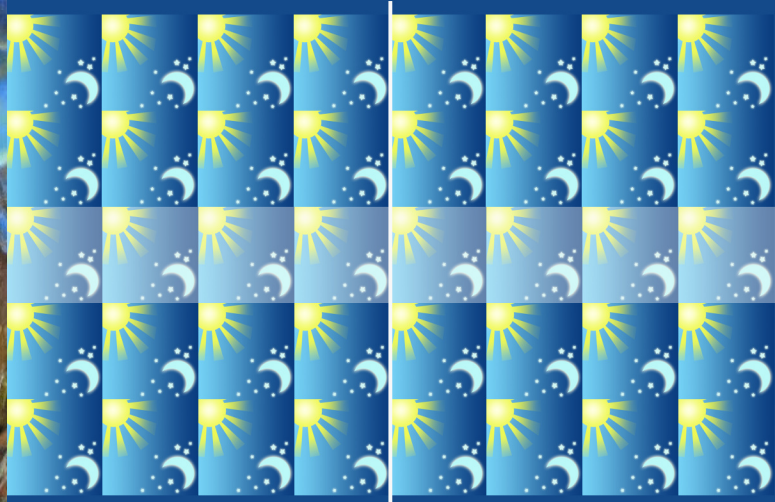

¹⁸So Moses went into the midst of the cloud and went up into the mountain.
Exodus 24: 18a

And Moses was on the mountain forty days and forty nights.
Exodus 24: 18b

68

69



Offerings for the Sanctuary

Chapter 25: ¹Then the LORD spoke to Moses, saying:
²“Speak to the children of Israel, that they bring Me an offering. From everyone who gives it willingly with his heart you shall take My offering.
Exodus 25: 1-2

³And this is the offering which you shall take from them: gold, silver, and bronze;
Exodus 25: 3

70

71



⁴blue, purple, and scarlet thread, fine linen,
Exodus 25:4a

72



and goats' hair; ⁵ram skins dyed red, badger skins, and
acacia wood; Exodus 25:4b-5

73



⁶oil for the light, and spices for the anointing oil and for
the sweet incense; Exodus 25:6

74



⁷onyx stones, and stones to be set in the ephod and in the
breastplate. Exodus 25:7

75

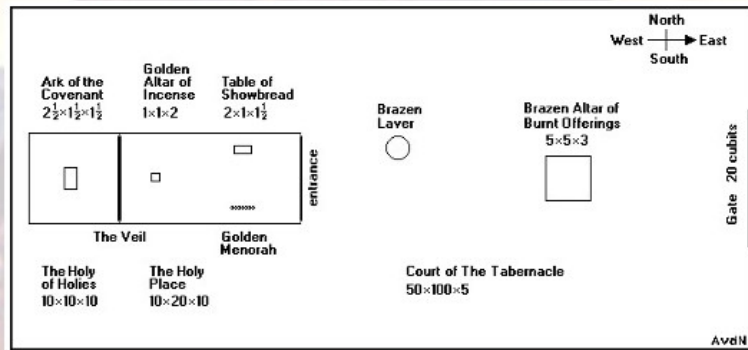

⁸ And let them make Me a sanctuary, that I may dwell among them. Exodus 25 : 8

⁹ According to all that I show you, that is, the pattern of the tabernacle and the pattern of all its furnishings, just so you shall make it. Exodus 25 : 9

76

77

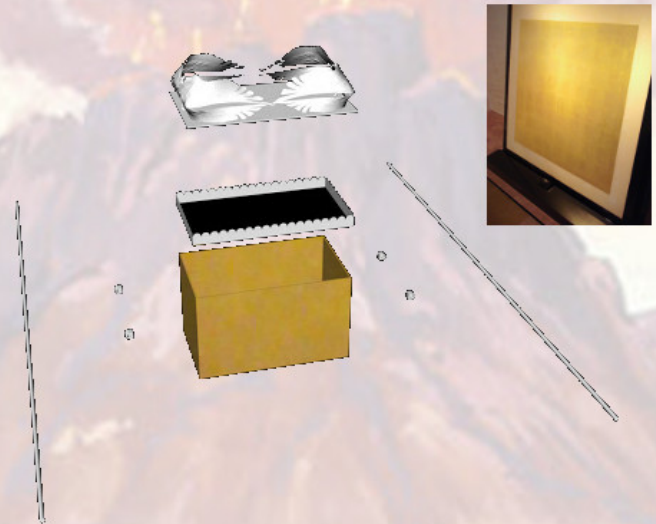
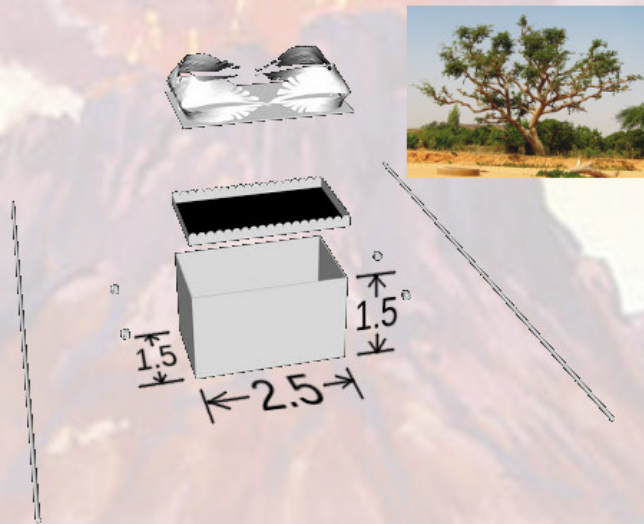

The Ark of the Testimony

¹⁰ “And they shall make an ark of acacia wood; two and a half cubits shall be its length, a cubit and a half its width, and a cubit and a half its height. Exodus 25 : 10

¹¹ And you shall overlay it with pure gold, inside and out you shall overlay it, Exodus 25 : 11a

78

79



and shall make on it a molding of gold all around.
Exodus 25 : 11b

¹² You shall cast four rings of gold for it, and put them in its four corners; two rings shall be on one side, and two rings on the other side.
Exodus 25 : 12

80

81



¹³ And you shall make poles of acacia wood, and overlay them with gold.
Exodus 25 : 13

¹⁴ You shall put the poles into the rings on the sides of the ark, that the ark may be carried by them. ¹⁵ The poles shall be in the rings of the ark; they shall not be taken from it.
Exodus 25 : 14-15

82

83

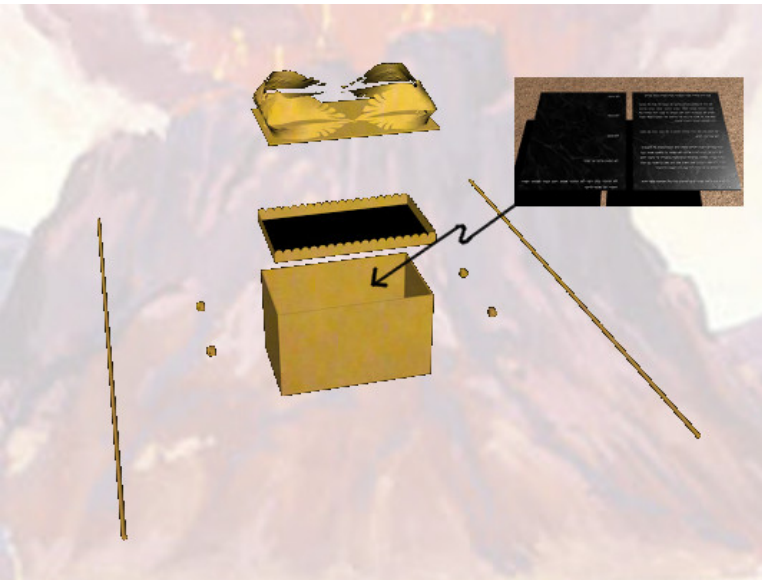

16 And you shall put into the ark the Testimony which I will give you. Exodus 25 : 16

84

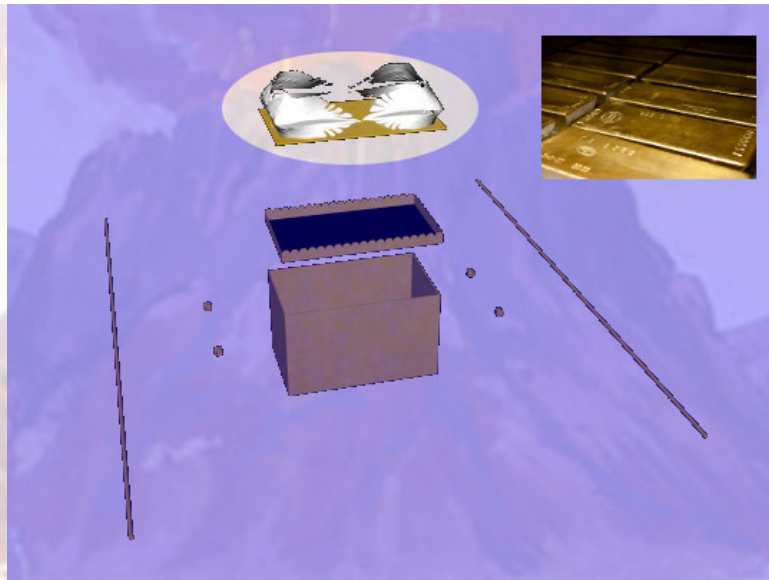

17 "You shall make a mercy seat of pure gold; two and a half cubits shall be its length and a cubit and a half its width. Exodus 25 : 17

85



Ezekiel 1 and 10 describe beasts that are called cherubim that look like this.

18 And you shall make two cherubim of gold; of hammered work you shall make them at the two ends of the mercy seat. Exodus 25 : 18

86

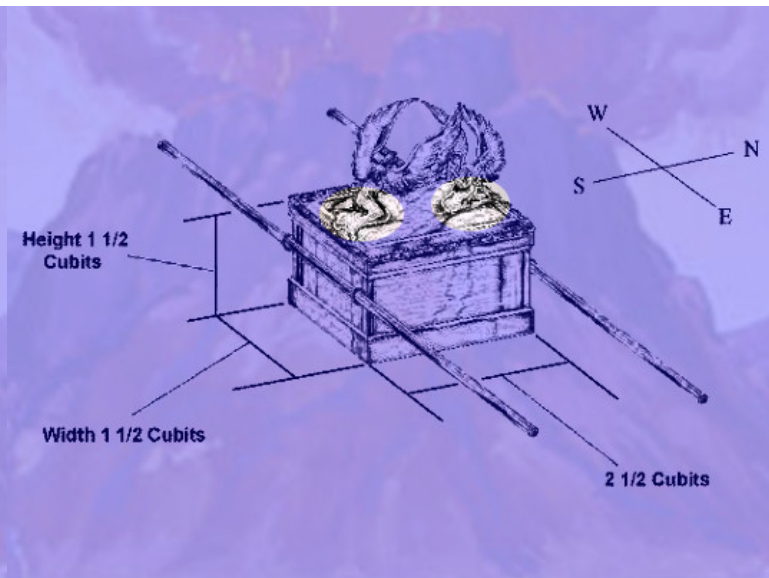

19 Make one cherub at one end, and the other cherub at the other end; you shall make the cherubim at the two ends of it of one piece with the mercy seat. Exodus 25 : 19

87

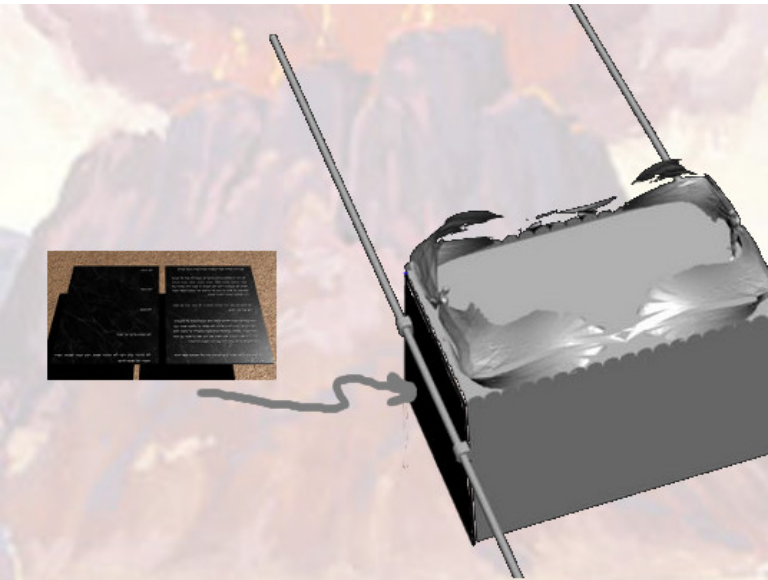
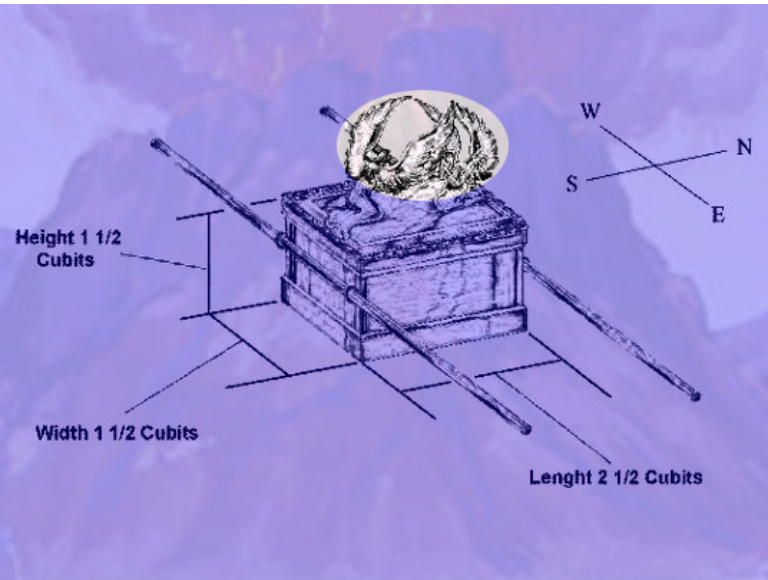

20 And the cherubim shall stretch out their wings above, covering the mercy seat with their wings, and they shall face one another; the faces of the cherubim shall be toward the mercy seat.
Exodus 25 : 20

21 You shall put the mercy seat on top of the ark, and in the ark you shall put the Testimony that I will give you.
Exodus 25 : 21

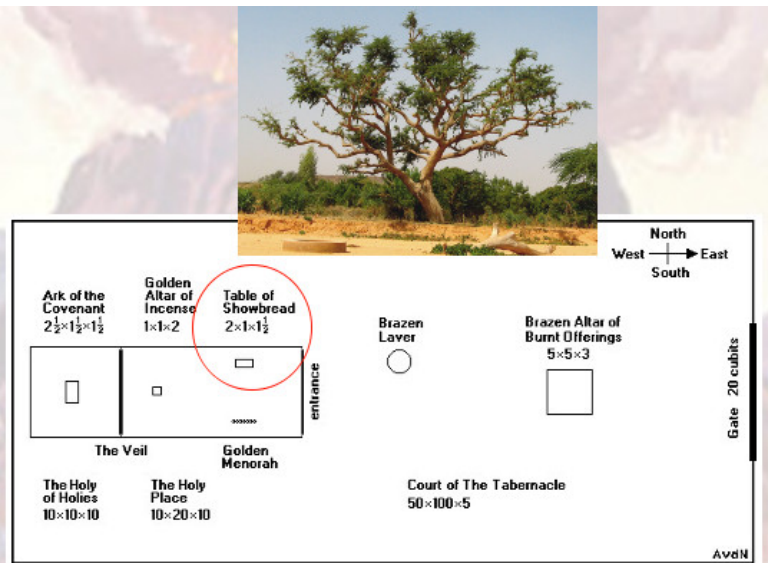
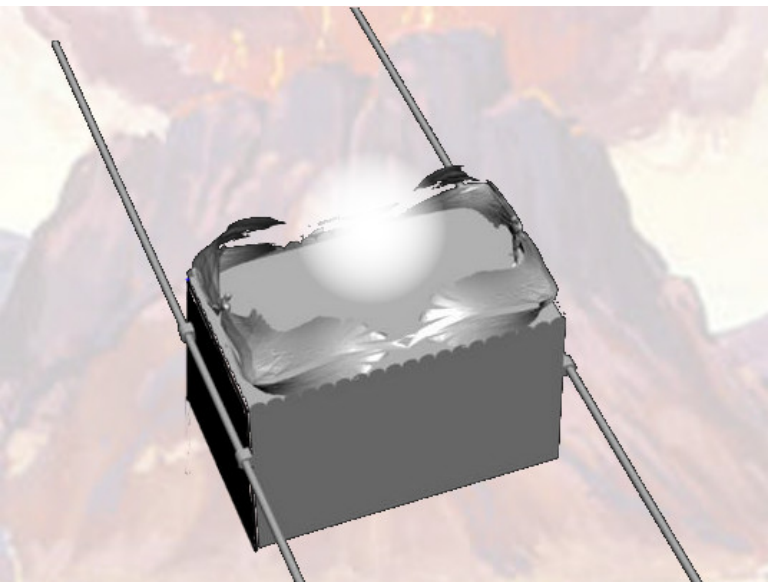

The Table for the Showbread

22 And there I will meet with you, and I will speak with you from above the mercy seat, from between the two cherubim which are on the ark of the Testimony, about everything which I will give you in commandment to the children of Israel.
Exodus 25 : 22

23 "You shall also make a table of acacia wood; two cubits shall be its length, a cubit its width, and a cubit and a half its height.
Exodus 25 : 23

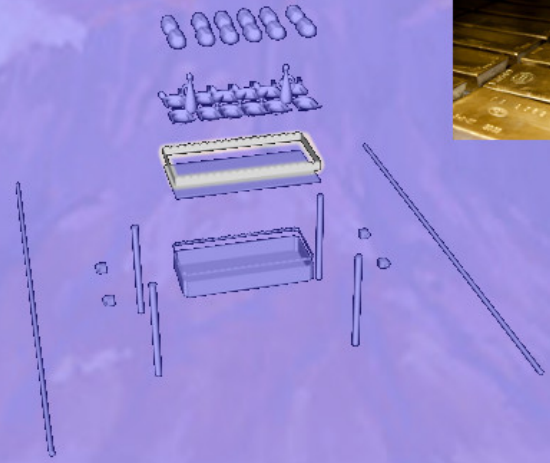
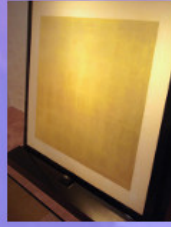
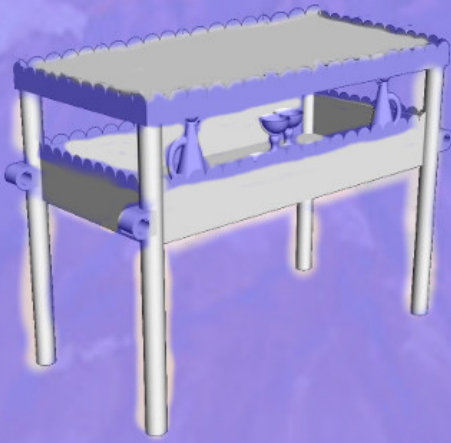

24 And you shall overlay it with pure gold,
Exodus 25 : 24a

and make a molding of gold all around. Exodus 25 : 24b

92

93

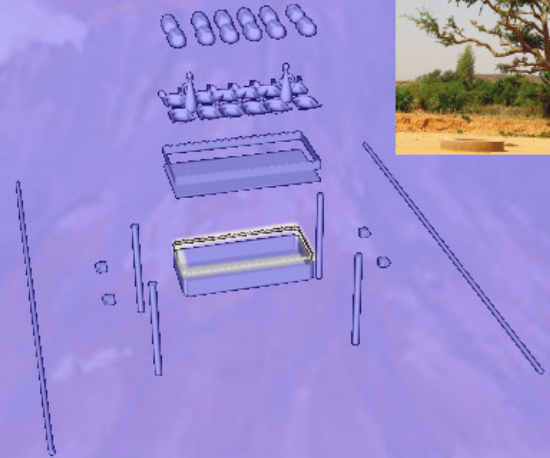
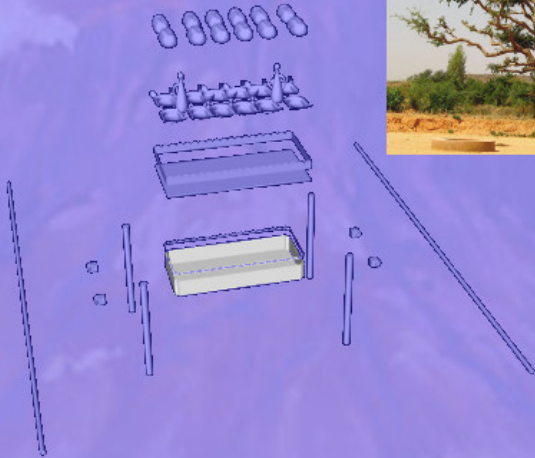

25 You shall make for it a frame of a handbreadth all
around,
Exodus 25 : 25a

and you shall make a gold molding for the frame all around.
Exodus 25 : 25b

94

95



²⁶ And you shall make for it four rings of gold, and put the rings on the four corners that are at its four legs. ²⁷ The rings shall be close to the frame, as holders for the poles to bear the table. Exodus 25 : 26-27

96

²⁸ And you shall make the poles of acacia wood, and overlay them with gold, that the table may be carried with them. Exodus 25 : 28

97

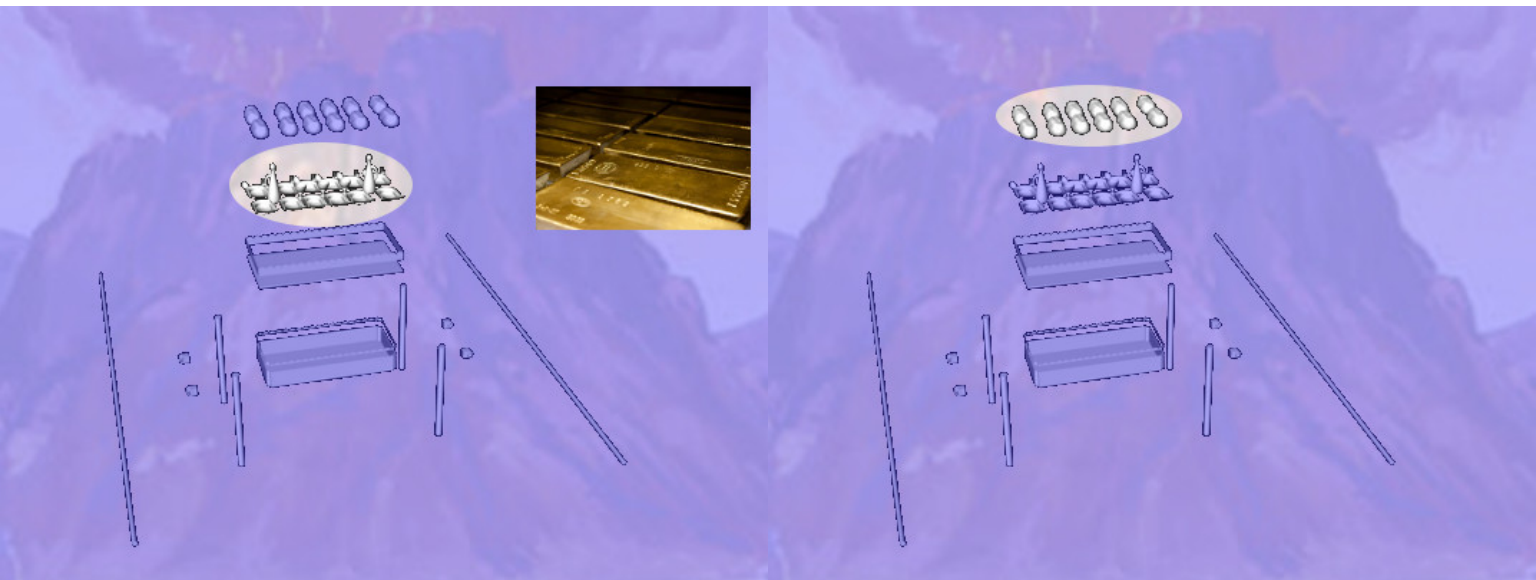

²⁹ You shall make its dishes, its pans, its pitchers, and its bowls for pouring. You shall make them of pure gold. Exodus 25 : 29

98

³⁰ And you shall set the showbread on the table before Me always. Exodus 25 : 30

99



The Gold Lampstand

³¹ “You shall also make a lampstand of pure gold; the lampstand shall be of hammered work. Exodus 25 : 31a

Schematic Diagram of the Menorah
(not to scale; parts are of an arbitrary shape and shown separately)

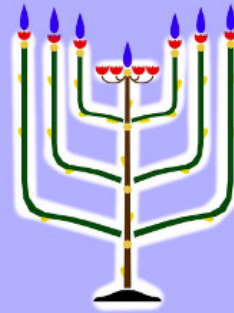

- 7 Lamps (♫)
- 10 Flowers (♥)
- 10 Knops (•)
- 22 Cups (♪)
- 6 Branches (—)
- 1 Stem (—)
- 1 Base (—)

Its shaft, its branches, its bowls, its ornamental knobs, and flowers shall be of one piece. Exodus 35 : 31b

Schematic Diagram of the Menorah

(not to scale; parts are of an arbitrary shape and shown separately)

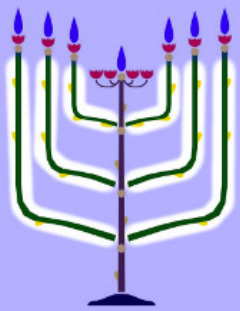

- 7 Lamps (♫)
- 10 Flowers (♥)
- 10 Knops (•)
- 22 Cups (♪)
- 6 Branches (—)
- 1 Stem (—)
- 1 Base (—)

³² And six branches shall come out of its sides: three branches of the lampstand out of one side, and three branches of the lampstand out of the other side.

Exodus 25 : 32

Schematic Diagram of the Menorah

(not to scale; parts are of an arbitrary shape and shown separately)

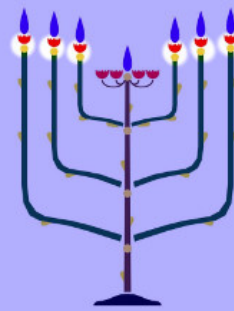

- 7 Lamps (♫)
- 10 Flowers (♥)
- 10 Knops (•)
- 22 Cups (♪)
- 6 Branches (—)
- 1 Stem (—)
- 1 Base (—)

³³ Three bowls shall be made like almond blossoms on one branch, with an ornamental knob and a flower, and three bowls made like almond blossoms on the other branch, with an ornamental knob and a flower—and so for the six branches that come out of the lampstand.

Exodus 25 : 33

Schematic Diagram of the Menorah
(not to scale; parts are of an arbitrary shape and shown separately)

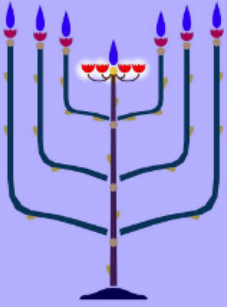

- 7 Lamps (♯)
- 10 Flowers (♥)
- 10 Knops (•)
- 22 Cups (♣)
- 6 Branches (—)
- 1 Stem (—)
- 1 Base (⌒)

³⁴On the lampstand itself four bowls shall be made like almond blossoms, each with its ornamental knob and flower.
Exodus 25 : 34

Schematic Diagram of the Menorah
(not to scale; parts are of an arbitrary shape and shown separately)

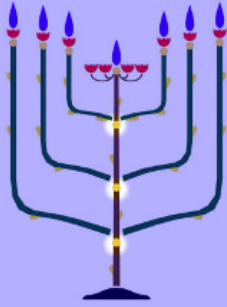

- 7 Lamps (♯)
- 10 Flowers (♥)
- 10 Knops (•)
- 22 Cups (♣)
- 6 Branches (—)
- 1 Stem (—)
- 1 Base (⌒)

³⁵And there shall be a knob under the first two branches of the same, a knob under the second two branches of the same, and a knob under the third two branches of the same, according to the six branches that extend from the lampstand.
Exodus 25 : 35

Schematic Diagram of the Menorah
(not to scale; parts are of an arbitrary shape and shown separately)

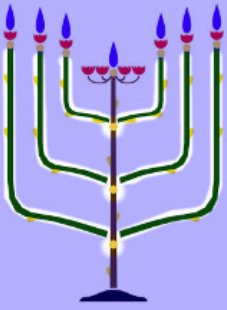

- 7 Lamps (♯)
- 10 Flowers (♥)
- 10 Knops (•)
- 22 Cups (♣)
- 6 Branches (—)
- 1 Stem (—)
- 1 Base (⌒)

³⁶Their knobs and their branches shall be of one piece; all of it shall be one hammered piece of pure gold.
Exodus 25 : 36

Schematic Diagram of the Menorah
(not to scale; parts are of an arbitrary shape and shown separately)

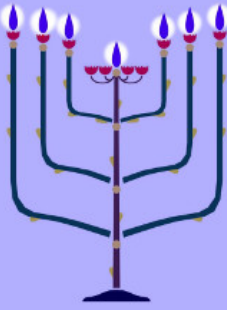

- 7 Lamps (♯)
- 10 Flowers (♥)
- 10 Knops (•)
- 22 Cups (♣)
- 6 Branches (—)
- 1 Stem (—)
- 1 Base (⌒)

³⁷You shall make seven lamps for it, and they shall arrange its lamps so that they give light in front of it.
Exodus 25 : 37

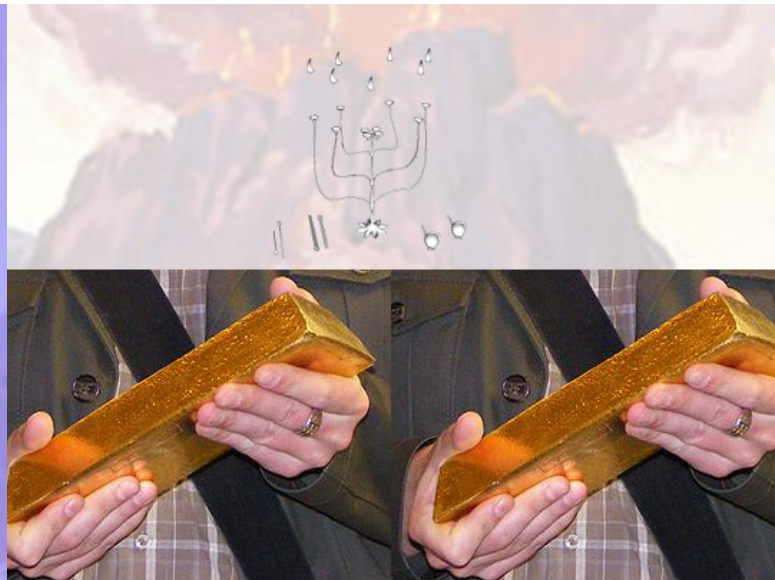

³⁸ And its wick-trimmers and their trays shall be of pure gold. Exodus 25:38

Good Delivery gold bar weighing 12.4 kg (400 troy ounces). One Egyptian talent was 27 kg (60 lb) So the Candlestick was made with approx. 2 of these bars. Price per Troy ounce is 1180 USD on June 30, 2015. Total value of the candlestick today is 944,000 USD

³⁹It shall be made of a talent of pure gold, with all these utensils. ⁴⁰ And see to it that you make them according to the pattern which was shown you on the mountain.

Questions for Exodus 23-25

There are many useful questions for Exodus 23-25 at <http://www.pbequizengine.com/>

Exodus Chapter 23

- 1) What were the three feasts and what laws pertained to them? ([Exodus 23:14-19](#))
- 2) Who was the Lord sending and for what purpose? ([Exodus 23:20](#))
- 3) What were they to do and not do regarding the angel? ([Exodus 23:21](#))
- 4) If the people listened and obeyed what would the Lord do in return? ([Exodus 23:22](#))
- 5) Who was the Lord going to wipe out? ([Exodus 23:23](#))
- 6) What were they to do to the other gods? ([Exodus 23:24](#))
- 7) What four things did the Lord promise if they worshipped the Lord? ([Exodus 23:25-26](#))
- 8) What would go before them? ([Exodus 23:20](#)), ([Exodus 23:27-28](#))
- 9) How were the Hivites, Canaanites, Hittites to be driven out? ([Exodus 23:29-30](#))
- 10) What would be the borders of the land established by the Lord? ([Exodus 23:31](#))
- 11) What were the Israelites to not make with the inhabitants of the land and why? ([Exodus 23:32-33](#))

Exodus Chapter 24

- 1) Who was to come up to the Lord, according to verse one? ([Exodus 24:1](#))
- 2) Who alone could approach the Lord, according to this verse? ([Exodus 24:2](#))
- 3) What was the people's response to the Lord's laws? ([Exodus 24:3](#))
- 4) What did Moses do with what God had said? ([Exodus 24:4](#))
- 5) What did Moses build? Why the 12 stones? ([Exodus 24:4](#))
- 6) What kind of offerings were made and by whom? ([Exodus 24:5](#))
- 7) What did Moses do with the blood? ([Exodus 24:6](#))
- 8) What did Moses read to the people? ([Exodus 24:7](#))
- 9) What did Moses do with the blood he had saved? ([Exodus 24:8](#))
- 10) What was under God's feet? ([Exodus 24:9](#))
- 11) Who saw God, according to these verses? ([Exodus 24:9-11](#))
- 12) What was God going to give Moses? What did they contain? ([Exodus 24:12](#))
- 13) Who was to settle disputes while Moses was gone? ([Exodus 24:14](#))
- 14) What covered the mountain and how long? ([Exodus 24:15-16](#))
- 15) When did God call to Moses? ([Exodus 24:16](#))
- 16) What did the glory of the Lord look like to the Israelites? ([Exodus 24:17](#))
- 17) How long was Moses on the mountain, according to verse eighteen? ([Exodus 24:18](#))

Exodus Chapter 25

- 1) Who was Moses to receive offerings from? ([Exodus 25:2](#))
- 2) What were the offerings to consist of? ([Exodus 25:3-7](#))
- 3) What were all these offerings for? ([Exodus 25:8](#))
- 4) How were they going to know how to build the tabernacle? ([Exodus 25:9](#))
- 5) Of what was the chest made? What were its dimensions? ([Exodus 25:10](#))
- 6) How was gold to be used in making the chest? ([Exodus 25:11-13](#))
- 7) Please describe the atonement cover and the cherubim. ([Exodus 25:17-20](#))
- 8) Where was the cover placed? ([Exodus 25:21](#))
- 9) What was put inside the ark? ([Exodus 25:21](#))
- 10) Where would God meet with them and for what reason? ([Exodus 25:22](#))
- 11) Of what would was the table made? What were its dimensions? ([Exodus 25:23](#))
- 12) How was gold used in making the table? ([Exodus 25:24-26](#))
- 13) What dishes were made and of what? ([Exodus 25:29](#))
- 14) What was to be put on the table? ([Exodus 25:30](#))
- 15) What was to be hammered on the lamp stand? ([Exodus 25:31](#))
- 16) What was to be made one piece with the lamp stand? ([Exodus 25:31](#))
- 17) How many branches did the lamp stand have? ([Exodus 25:32](#))
- 18) Where and how many cups were on the lamp stand and branches? ([Exodus 25:33-36](#))
- 19) How much gold was to be used for the lamp stands and its accessories? ([Exodus 25:39](#))

Note: I pray that these questions have helped your study and understanding of Gods' word in the Bible. Please feel free to pass them on to other people if they have helped you.

Your Brother in Christ,



Frank Rose <http://my-ccm.com/old-testament-questions/questions-about-the-book-of-exodus/>



Unit EG

Exodus 23-25

Bill and Shelley Houser
<http://www.ReadyAnswers.org>

Ark of the Covenant 2½×1½×1½	Golden Altar of Incense 1×1×2	Table of Showbread 2×1×1½	Brazen Laver ○	Brazen Altar of Burnt Offerings 5×5×3
The Veil		Golden Menorah	Gate 20 cubits	
The Holy of Holies 10×10×10	The Holy Place 10×20×10	23-25		

AveN

Scripture taken from the Reina-Valera 1995 version.

Reina-Valera 95 © Sociedades Biblicas Unidas, 1995. Used by permission.



Justice for All

Capítulo 23: ¹>>No admitirás falso rumor.

Éxodo 23:1a

No te pondrás de acuerdo con el malvado para ser testigo falso.

Éxodo 23:1b



²>>No seguirás a la mayoría para hacer mal,
Éxodo 23:2a

ni responderás en un litigio inclinándote a la mayoría para
hacer agravios. Éxodo 23:2b

4

5



³Tampoco favorecerás al pobre en su causa. Éxodo 23:3

⁴>>Si encuentras el buey de tu enemigo o su asno
extraviado, regresa a llevárselo. Éxodo 23:4

6

7

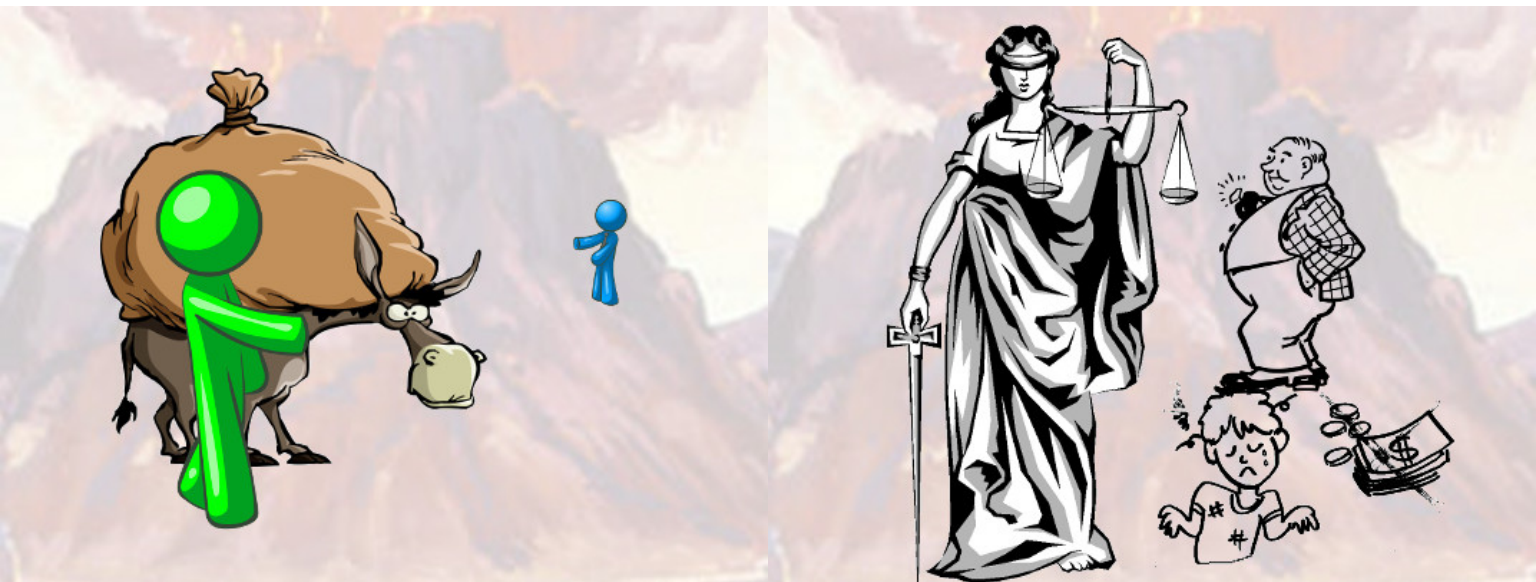

⁵ Si ves el asno del que te aborrece caído debajo de su carga, ¿lo dejarás sin ayuda? Antes bien le ayudarás a levantarlo.
Éxodo 23 : 5

⁶ >> No violarás el derecho del pobre en su pleito.
Éxodo 23 : 6

8

9



⁷ >> De palabra de mentira te alejarás, y no matarás al inocente y justo, porque yo no justificaré al malvado.
Éxodo 23 : 7

⁸ >> No recibirás soborno, porque el soborno ciega a los que ven y pervierte las palabras de los justos.
Éxodo 23 : 8

10

11



The Law of Sabbaths

⁹>>No oprimirás al extranjero, porque vosotros sabéis cómo es el alma del extranjero, ya que extranjeros fuisteis en la tierra de Egipto..
Éxodo 23 :9

¹⁰>>Seis años sembrarás tu tierra y recogerás su cosecha,
Éxodo 23 :10

12

13

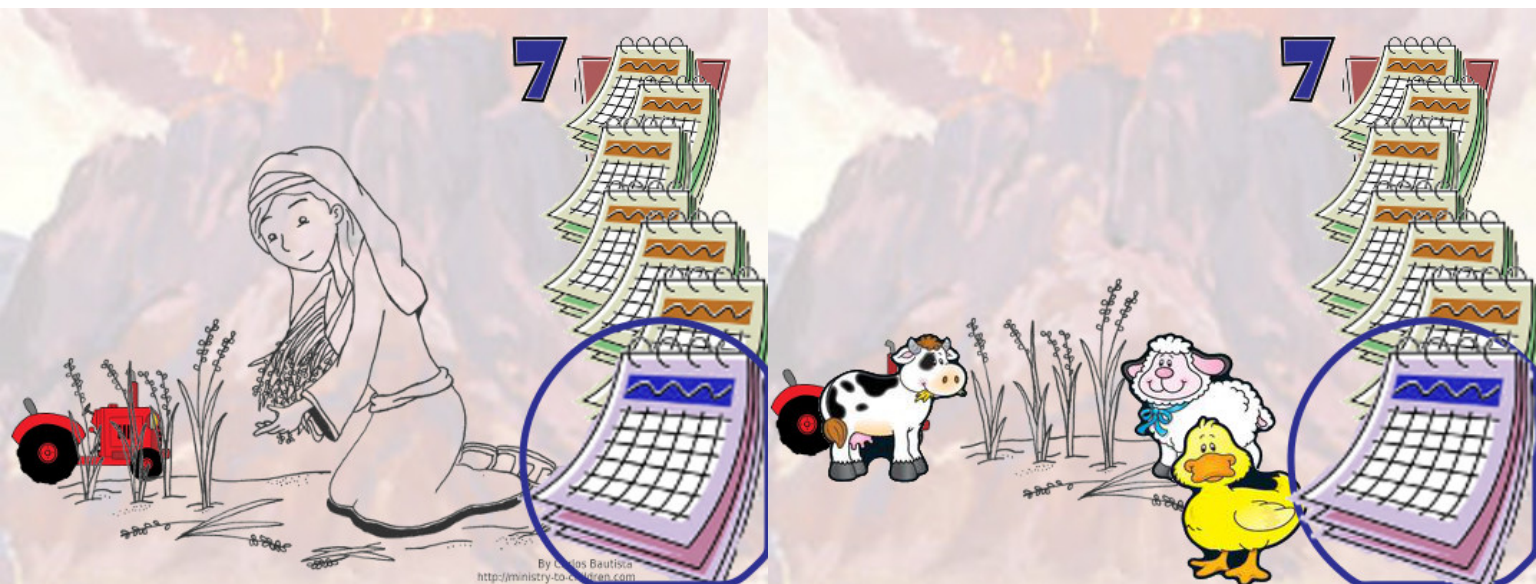

¹¹pero el séptimo año la dejarás libre, para que coman los pobres de tu pueblo,
Éxodo 23 :11a

y de lo que quede comerán las bestias del campo.
Éxodo 23 :11b

14

15

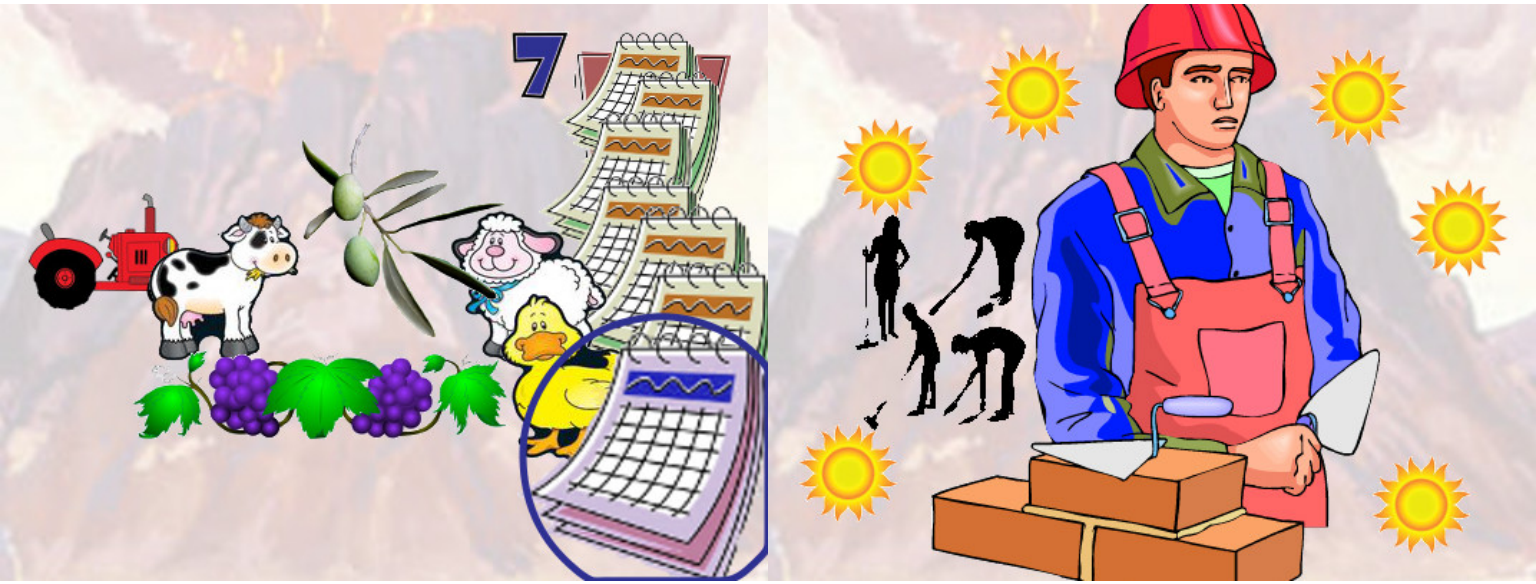

Así harás con tu viña y con tu olivar.

Éxodo 23 : 11c

¹²>>Seis días trabajarás,

Éxodo 23 : 12a

16

17

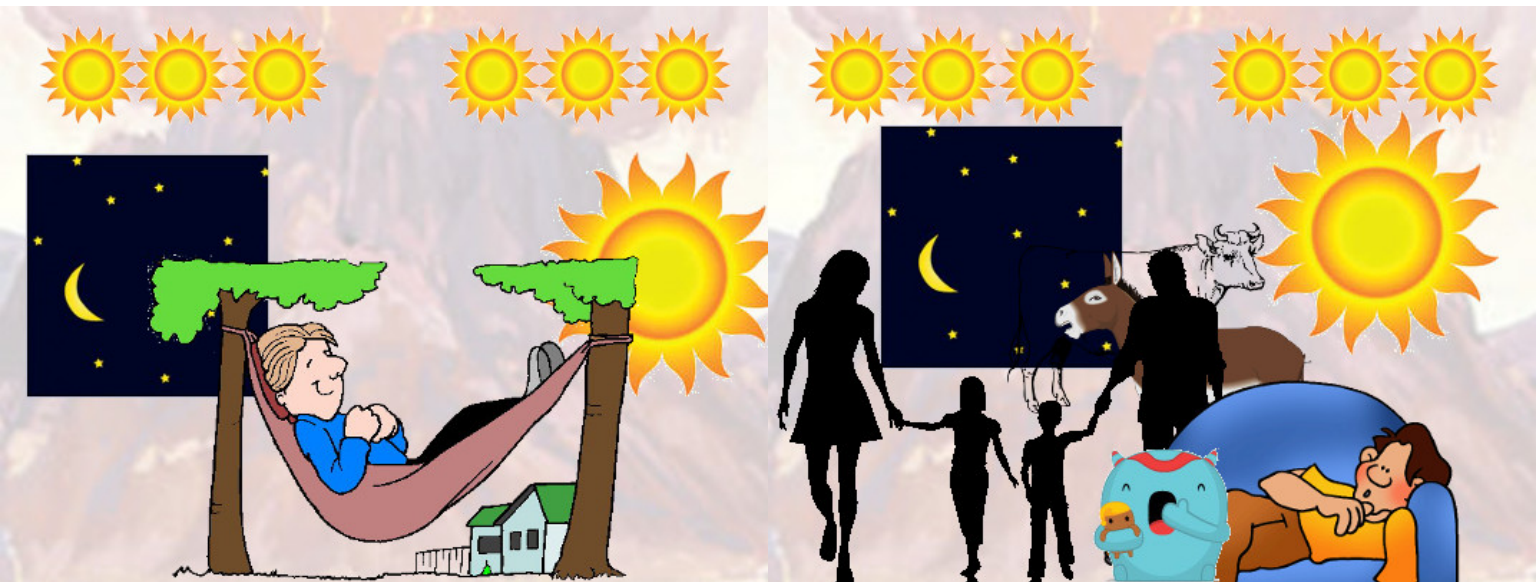

pero el séptimo día reposarás,

Éxodo 23 : 12b

para que descansen tu buey y tu asno, y tomen refrigerio el hijo de tu sierva y el extranjero.

Éxodo 23 : 12c

18

19



Las tres fiestas anuales

¹³ >> Guardad todo lo que os he dicho. No invocaréis el nombre de otros dioses ni los mencionará vuestra boca.
Éxodo 23:13

¹⁴ >> Tres veces al año me celebraréis fiesta.
Éxodo 23:14



¹⁵ La fiesta de los Panes sin levadura guardarás. Siete días comerás los panes sin levadura, como yo te mandé, en el tiempo del mes de Abib, porque en él saliste de Egipto; y ninguno se presentará ante mí con las manos vacías.
Éxodo 23:15

¹⁶ >> También la fiesta de la Siega, los primeros frutos de tus labores, de lo que hayas sembrado en el campo,
Éxodo 23:16a



y la fiesta de la Cosecha a la salida del año, cuando hayas recogido del campo los frutos de tus labores.

Éxodo 23:16b

17 >> Tres veces al año se presentará todo hombre delante de Jehová, el Señor.

Éxodo 23:17

24

25



18 >> No ofrecerás con pan leudado la sangre de mi sacrificio,

Éxodo 23:18a

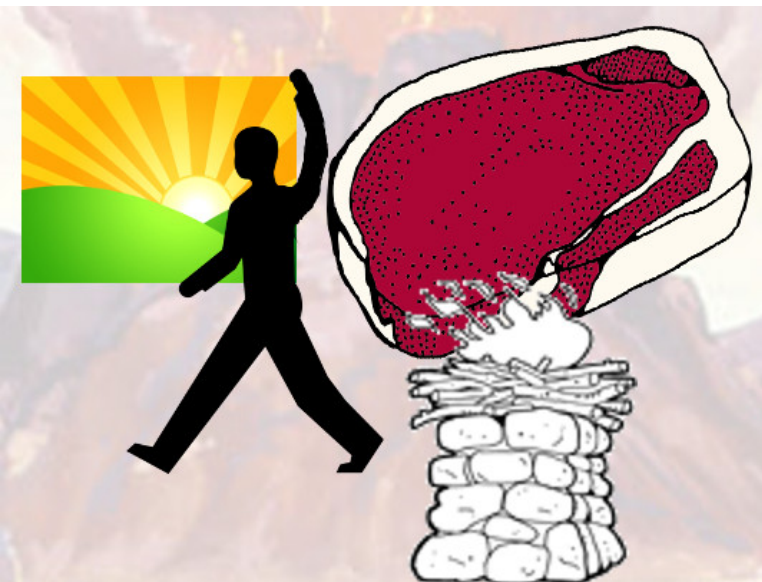

ni la grasa de la víctima quedará de la noche hasta la mañana.

Éxodo 23:18b

26

27



¹⁹ >> Las primicias de los primeros frutos de tu tierra traerás a la casa de Jehová, tu Dios. Éxodo 23 : 19a

>> No guisarás el cabrito en la leche de su madre. Éxodo 23 : 19b

28

29



El ángel de Jehová enviado para guiar a Israel



²⁰ >> Yo envió mi ángel delante de ti, para que te guarde en el camino y te introduzca en el lugar que yo he preparado. Éxodo 23 : 20

²¹ Comportate delante de él y oye su voz; Éxodo 23 : 21a

30

31

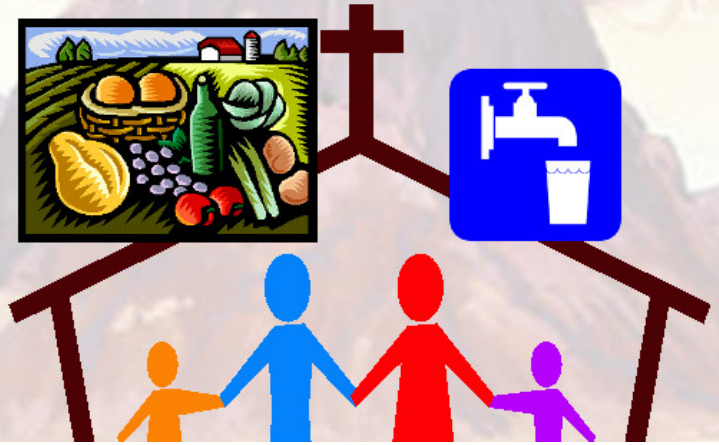

²⁴No te inclinarás ante sus dioses ni los servirás, ni harás como ellos hacen, sino que los destruirás del todo y quebrarás totalmente sus estatuas. Éxodo 23 : 24

²⁵Pero serviréis a Jehová, vuestro Dios, y él bendecirá tu pan y tus aguas. Éxodo 23 : 25a

36

37



Deuteronomy 7:13-14 mention animals, too

>>Yo apartaré de ti toda enfermedad. Éxodo 23 : 25b

²⁶En tu tierra no habrá mujer que aborte ni que sea estéril, Éxodo 23 : 26a

38

39



Rahab Told Spies Her People Were Afraid of the Israelites

y alargaré el número de tus días.

Éxodo 23 :26b

27 >>Yo enviaré mi terror delante de ti; turbaré a todos los pueblos donde entres y haré que todos tus enemigos huyan delante de ti.

Éxodo 23 :27

40

41



28 Enviaré delante de ti la avispa, que eche de tu presencia al heveo, al cananeo y al heteo.

Éxodo 23 :28

29 No los expulsaré de tu presencia en un año, para que no quede la tierra desierta ni se multipliquen contra ti las fieras del campo.

Éxodo 23 :29

42

43



³⁰ Poco a poco los echaré de tu presencia, hasta que te multipliques y tomes posesión de la tierra.

Éxodo 23 : 30

44

³¹ Fijaré tus límites desde el Mar Rojo hasta el mar de los filisteos y desde el desierto hasta el Éufrates, porque pondré en tus manos a los habitantes de la tierra y tú los arrojarás de delante de ti.

Éxodo 23 : 31

45



³² >>No harás alianza con ellos ni con sus dioses.

Éxodo 23 : 32

46

³³ En tu tierra no habitarán, no sea que te hagan pecar contra mí sirviendo a sus dioses, porque te será tropiezo.>>>

Éxodo 23 : 33

47

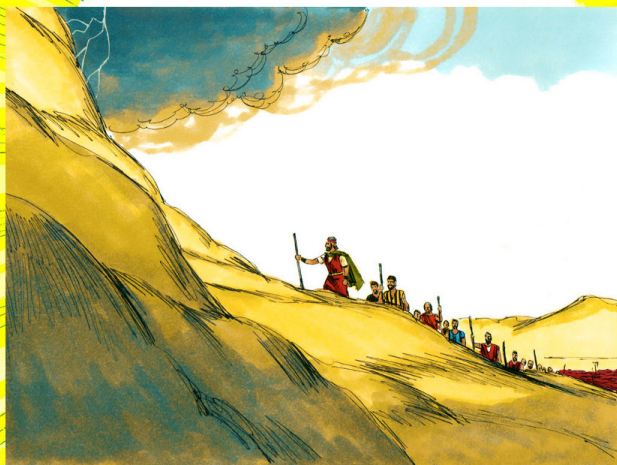

Picture used with permission: (c)2006 www.TheGloryStory.com

Moisés y los ancianos en el Monte Sinaí

Capítulo 24: ¹Dijo Jehová a Moisés: —Sube ante Jehová, junto con Aarón, Nadab, Abiú y setenta de los ancianos de Israel; y os inclinaréis de lejos. Éxodo 24:1

²Pero sólo Moisés se acercará a Jehová; que ellos no se acerquen ni suba el pueblo con él. Éxodo 24:2



³Moisés fue y le contó al pueblo todas las palabras de Jehová, y todas las leyes. Éxodo 24:3a

Y todo el pueblo respondió a una voz: —Cumpliremos todas las palabras que Jehová ha dicho. Éxodo 24:3b

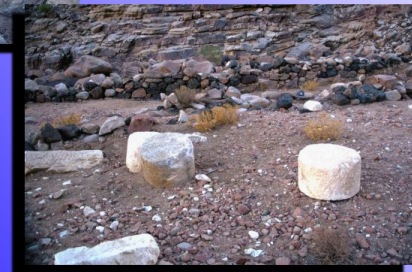
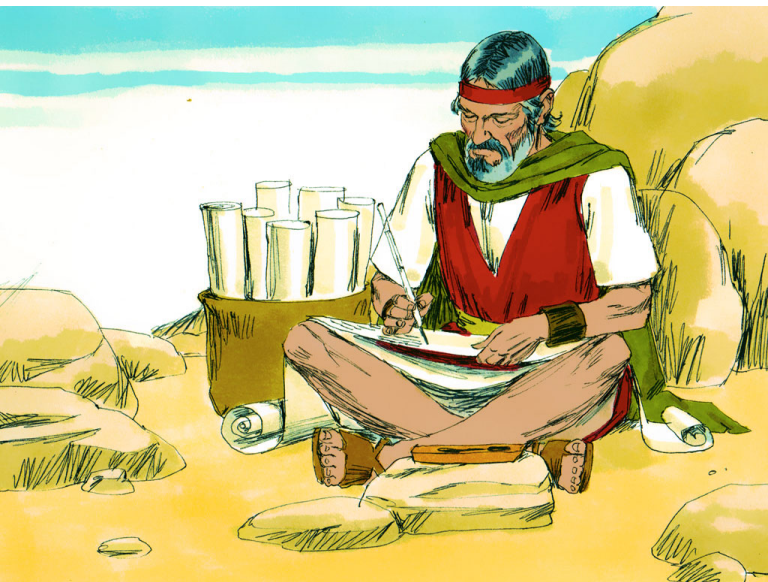

⁴Entonces Moisés escribió todas las palabras de Jehová,
Éxodo 24:4a

y levantándose de mañana edificó un altar y doce columnas
al pie del monte, una por cada tribu de Israel.

Éxodo 24:4b

52

53



⁵Luego envió jóvenes de los hijos de Israel, los cuales
ofrecieron holocaustos y becerros como sacrificios de paz
a Jehová.
Éxodo 24:5

⁶Moisés tomó la mitad de la sangre, la puso en tazones y
esparció la otra mitad de la sangre sobre el altar.

Éxodo 24:6

54

55



⁷Después tomó el libro del pacto y lo leyó a oídos del pueblo,

Éxodo 24:7a

56

el cual dijo:

—Obedeceremos y haremos todas las cosas que Jehová ha dicho.

Éxodo 24:7b

57



⁸Entonces Moisés tomó la sangre, la roció sobre el pueblo y dijo:

—Ésta es la sangre del pacto que Jehová ha hecho con vosotros sobre todas estas cosas.

Éxodo 24:8

58

⁹Subieron Moisés y Aarón, Nadab y Abiú, junto con setenta de los ancianos de Israel, ¹⁰y vieron al Dios de Israel.

Éxodo 24:9-10a

59

On the Mountain with God



Debajo de sus pies había como un embaldosado de zafiro, semejante al cielo cuando está sereno. Éxodo 24:10b

¹¹ Pero no extendió su mano contra los príncipes de los hijos de Israel: ellos vieron a Dios, comieron y bebieron. Éxodo 24:11

60

61

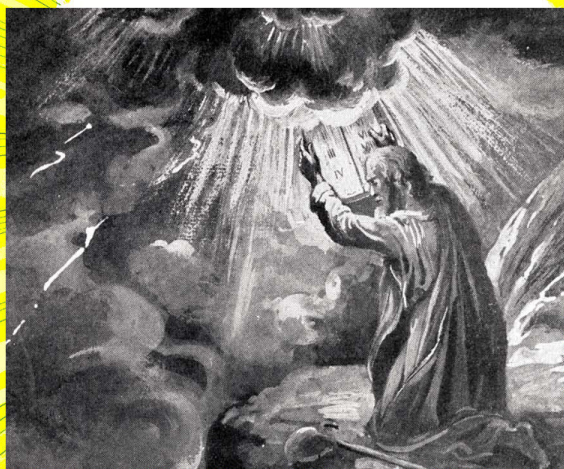

¹² Entonces Jehová dijo a Moisés: —Sube a mí al monte y espera allá, y te daré tablas de piedra con la ley y los mandamientos que he escrito para enseñarles. Éxodo 24:12

¹³ Se levantó Moisés junto con Josué, su servidor, y Moisés subió al monte de Dios. Éxodo 24:13

62

63



¹⁴ A los ancianos les dijo:
 —Esperadnos aquí hasta que volvamos. Aarón y Hur
 estarán con vosotros; el que tenga algún asunto, acuda
 a ellos.
 Éxodo 24:14



Picture used with permission: (c)2006 www.TheGloryStory.com

¹⁵ Entonces Moisés subió al monte. Una nube cubrió el
 monte,
 Éxodo 24:15

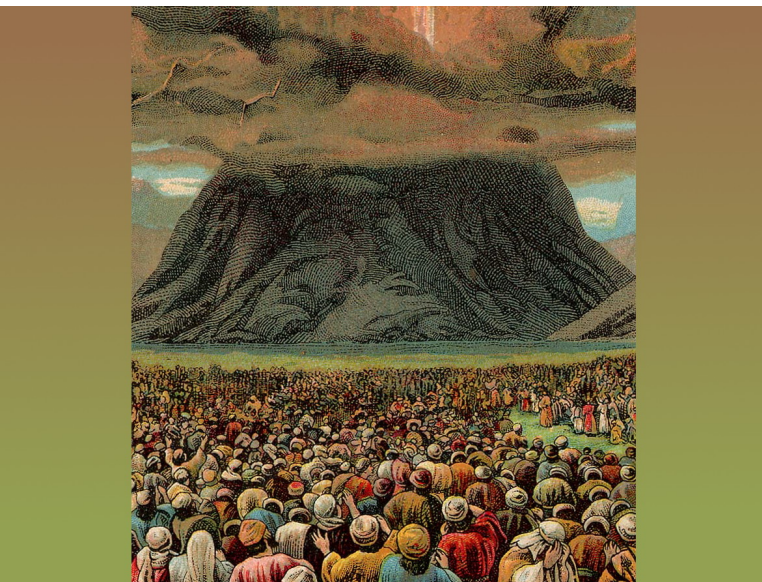

¹⁶ y la gloria de Jehová reposó sobre el monte Sinaí. La
 nube lo cubrió por seis días, y al séptimo día llamó a Moisés
 de en medio de la nube.
 Éxodo 24:16



Picture used with permission: (c)2006 www.TheGloryStory.com

¹⁷ La apariencia de la gloria de Jehová era, a los ojos de
 los hijos de Israel, como un fuego abrasador en la cumbre
 del monte.
 Éxodo 24:17

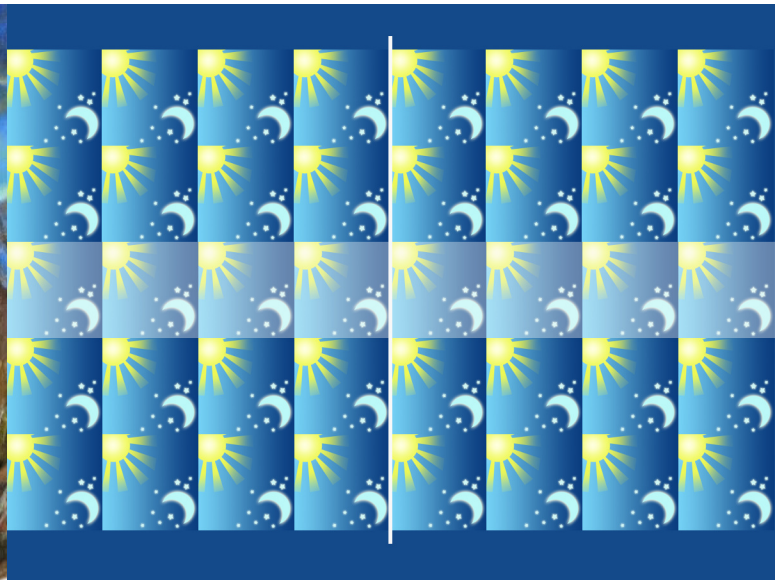

¹⁸ Moisés entró en medio de la nube y subió al monte.
Éxodo 24 : 18a

Y estuvo Moisés en el monte cuarenta días y cuarenta
noches.
Éxodo 24 : 18b

68

69



La ofrenda para el Tabernáculo

Capítulo 25: ¹ Jehová habló a Moisés y le dijo: ² <<Di a los hijos de Israel que recojan para mí una ofrenda. De todo hombre que la dé voluntariamente, de corazón, recogeréis mi ofrenda.
Éxodo 25 : 1-2

³ Ésta es la ofrenda que aceptaréis de ellos: oro, plata, cobre,
Éxodo 25 : 3

70

71



⁴ azul, púrpura, carmesí, lino fino,

Éxodo 25 : 4a

pelo de cabras, ⁵ pieles de carneros teñidas de rojo, pieles de tejones, madera de acacia,

Éxodo 25 : 4b-5

72

73

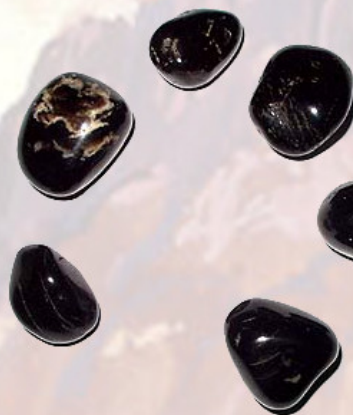

⁶ aceite para el alumbrado, especias para el aceite de la unción y para el incienso aromático,

Éxodo 25 : 6

⁷ piedras de ónice y piedras de engaste para el efod y para el pectoral.

Éxodo 25 : 7

74

75

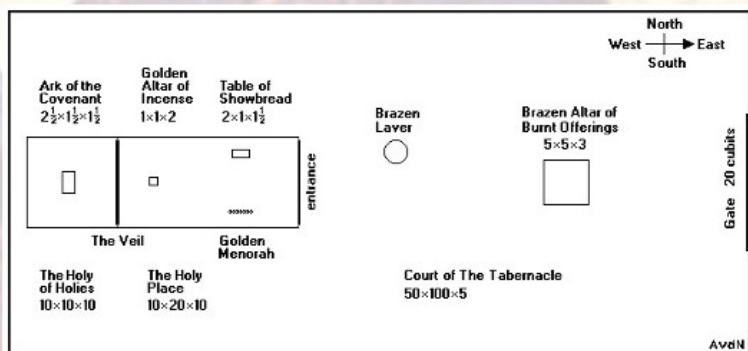

⁸ Me erigirán un santuario, y habitaré en medio de ellos.
Éxodo 25 : 8

⁹ Conforme a todo lo que yo te muestre, así haréis el diseño del Tabernáculo y el diseño de todos sus utensilios.
Éxodo 25 : 9

76

77

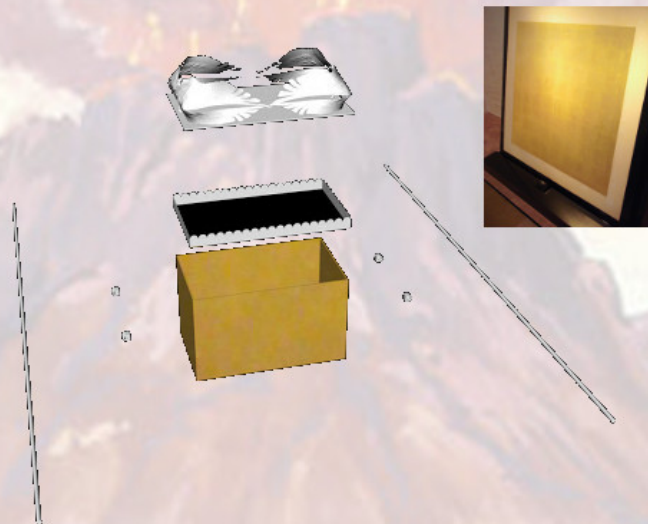
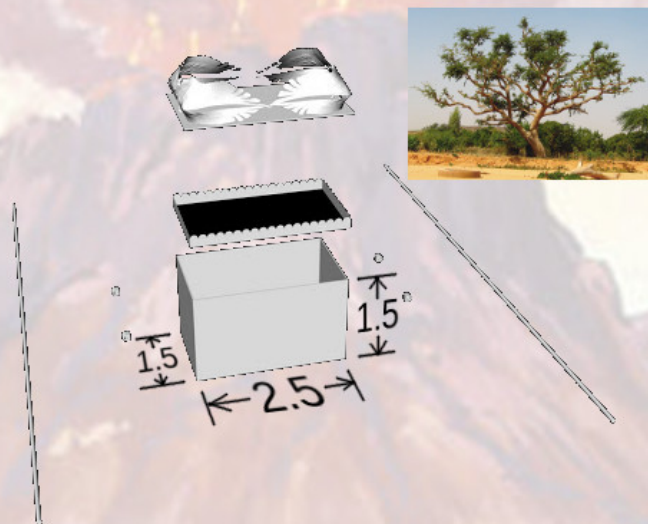

El Arca del testimonio

¹⁰ >> Harán también un arca de madera de acacia, cuya longitud será de dos codos y medio, su anchura de codo y medio, y su altura de codo y medio.
Éxodo 25 : 10

¹¹ La recubrirás de oro puro por dentro y por fuera,
Éxodo 25 : 11a

78

79



y pondrás encima y alrededor de ella una cornisa de oro.
Éxodo 25:11b

¹² Fundirás para ella cuatro argollas de oro, que pondrás en sus cuatro esquinas; dos argollas a un lado de ella y dos argollas al otro lado.
Éxodo 25:12

80

81



¹³ Harás unas varas de madera de acacia, las cuales cubrirás de oro.
Éxodo 25:13

¹⁴ Y meterás las varas por las argollas a los lados del Arca, para llevar el Arca con ellas. ¹⁵ Las varas quedarán en las argollas del Arca; no se quitarán de ella.
Éxodo 25:14-15

Éxodo 25:14-15

82

83

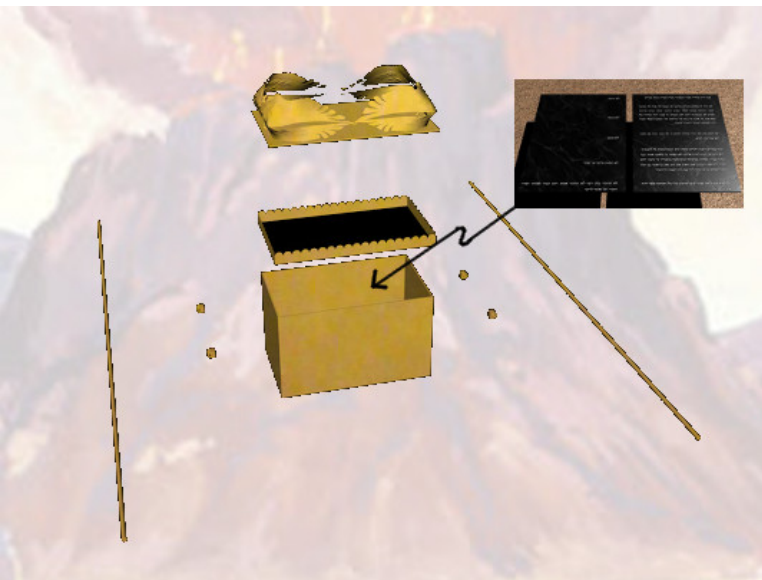

16 En el Arca pondrás el Testimonio que yo te daré.
Éxodo 25 : 16

84

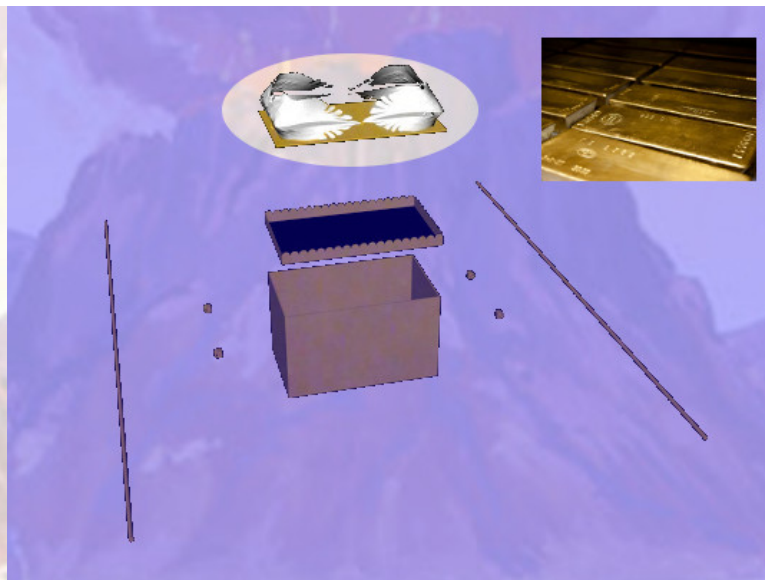

17 >> Harás un propiciatorio de oro fino, cuya longitud será de dos codos y medio, y su anchura de codo y medio.
Éxodo 25 : 17

85

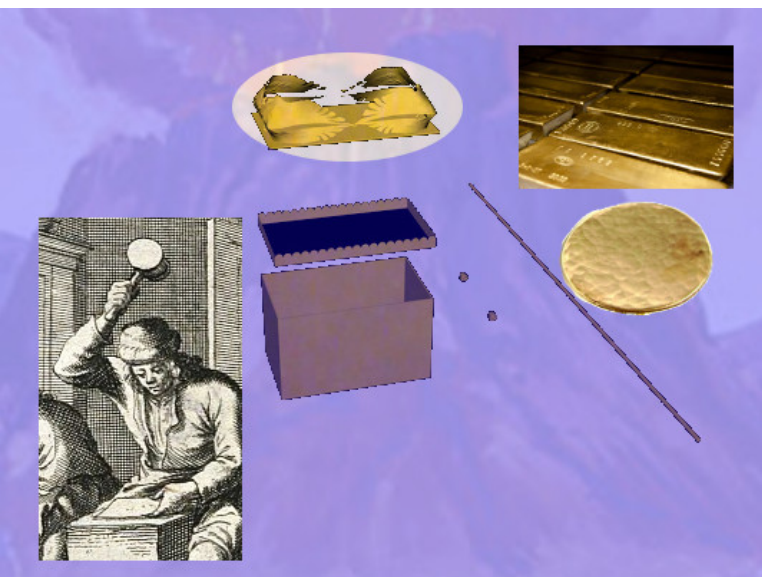

Ezekiel 1 and 10 describe beasts that are called cherubim that look like this.

18 Harás también dos querubines de oro; los harás labrados a martillo en los dos extremos del propiciatorio.
Éxodo 25 : 18

86

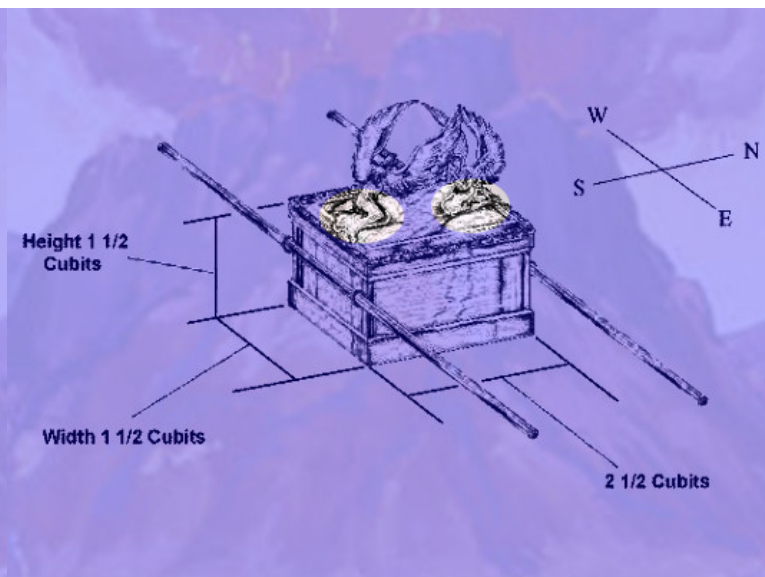

19 Harás, pues, un querubín en un extremo, y un querubín en el otro extremo; de una pieza con el propiciatorio harás los querubines en sus dos extremos.
Éxodo 25 : 19

87

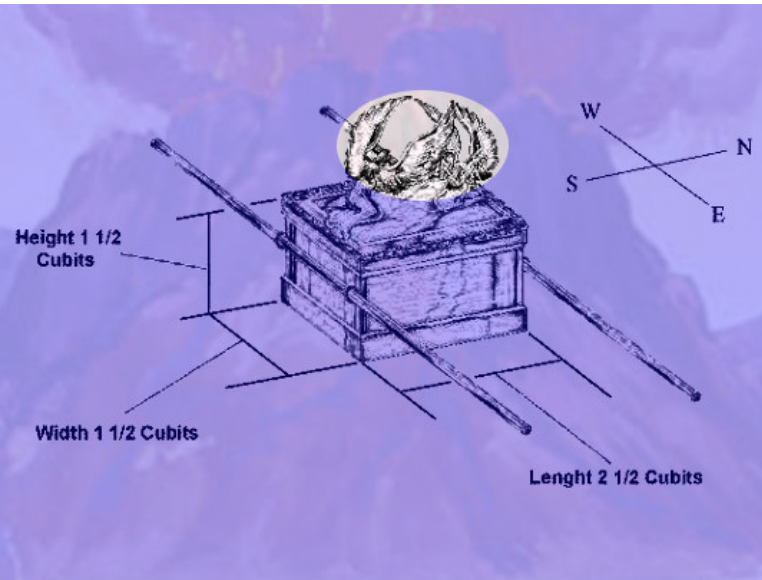

20 Los querubines extenderán por encima las alas, cubriendo con ellas el propiciatorio; estarán uno frente al otro, con sus rostros mirando hacia al propiciatorio. Éxodo 25 : 20

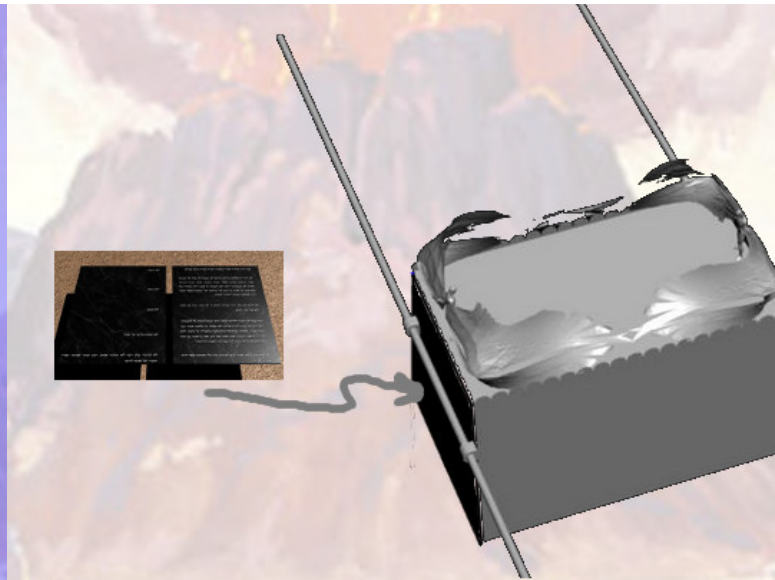

21 Después pondrás el propiciatorio encima del Arca, y en el Arca pondrás el Testimonio que yo te daré. Éxodo 25 : 21

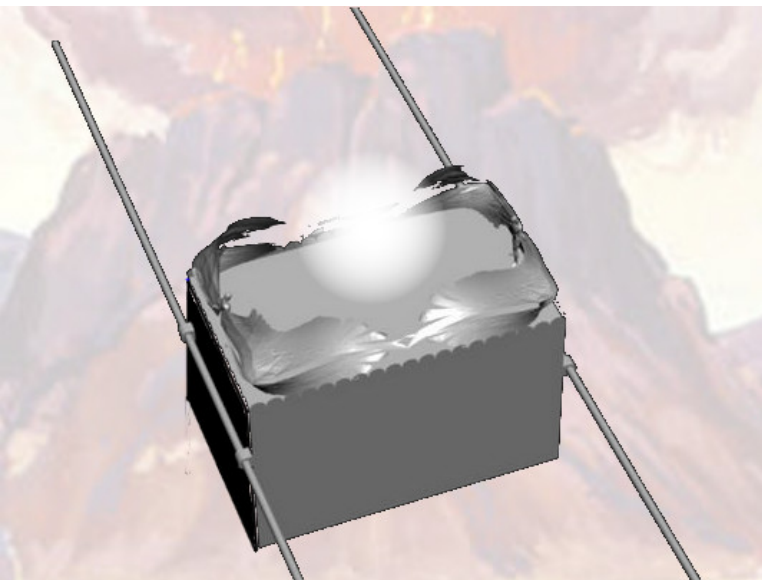

22 Allí me manifestaré a ti, y hablaré contigo desde encima del propiciatorio, de entre los dos querubines que están sobre el Arca del testimonio, todo lo que yo te mande para los hijos de Israel. Éxodo 25 : 22

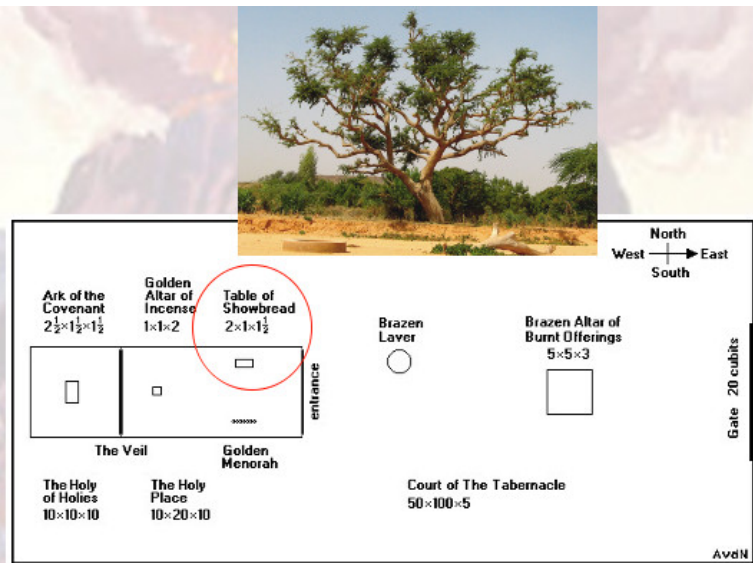

La mesa para el pan de la proposición

23 >>Harás asimismo una mesa de madera de acacia; su longitud será de dos codos, de un codo su anchura, y su altura de codo y medio. Éxodo 25 : 23

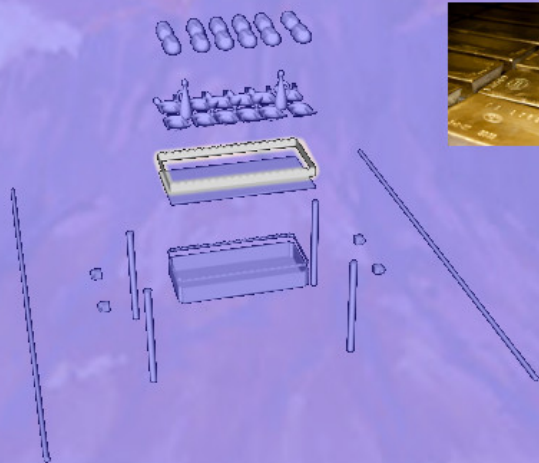
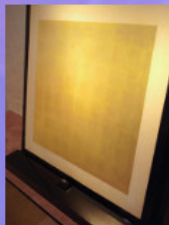
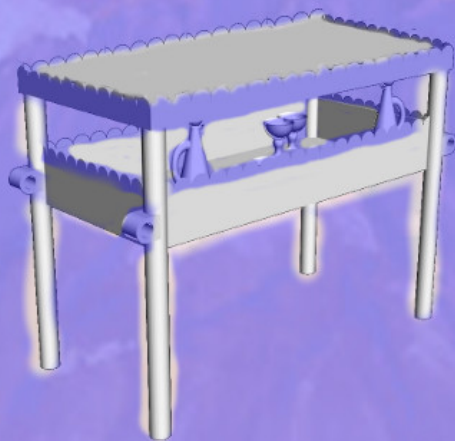

24 La recubrirás de oro puro

Éxodo 25 : 24a

y le harás una cornisa de oro alrededor.

Éxodo 25 : 24b

92

93

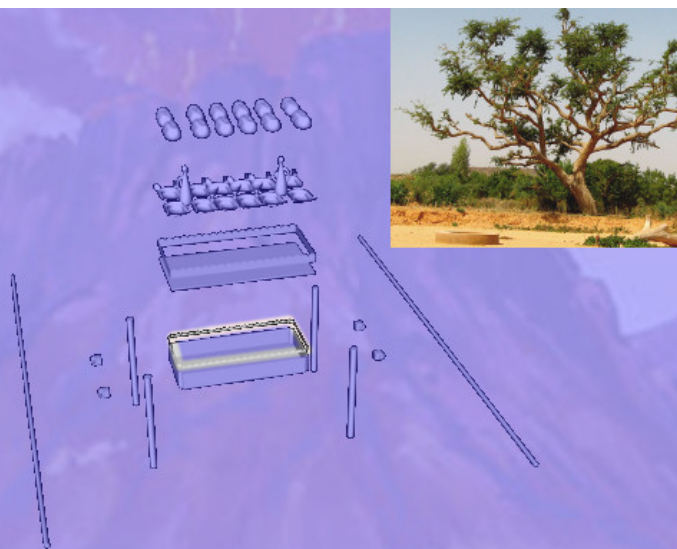
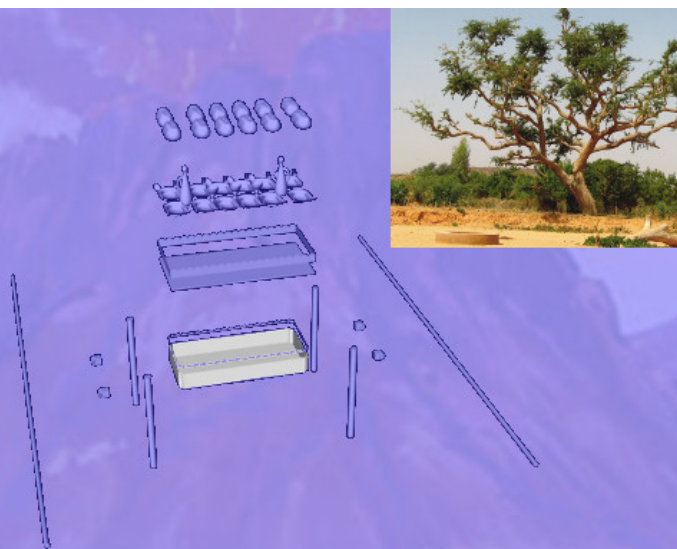

25 Le harás también una moldura alrededor, de un palmo menor de anchura,

Éxodo 25 : 25a

ay harás alrededor de la moldura una cornisa de oro.

Éxodo 25 : 25b

94

95



26 Le harás cuatro argollas de oro, las cuales pondrás en las cuatro esquinas que corresponden a sus cuatro patas.
 27 Las argollas estarán debajo de la moldura, y por ellas entrarán las varas para llevar la mesa. Éxodo 25:26-27

28 Harás las varas de madera de acacia, las cubrirás de oro, y con ellas será llevada la mesa. Éxodo 25:28

96

97

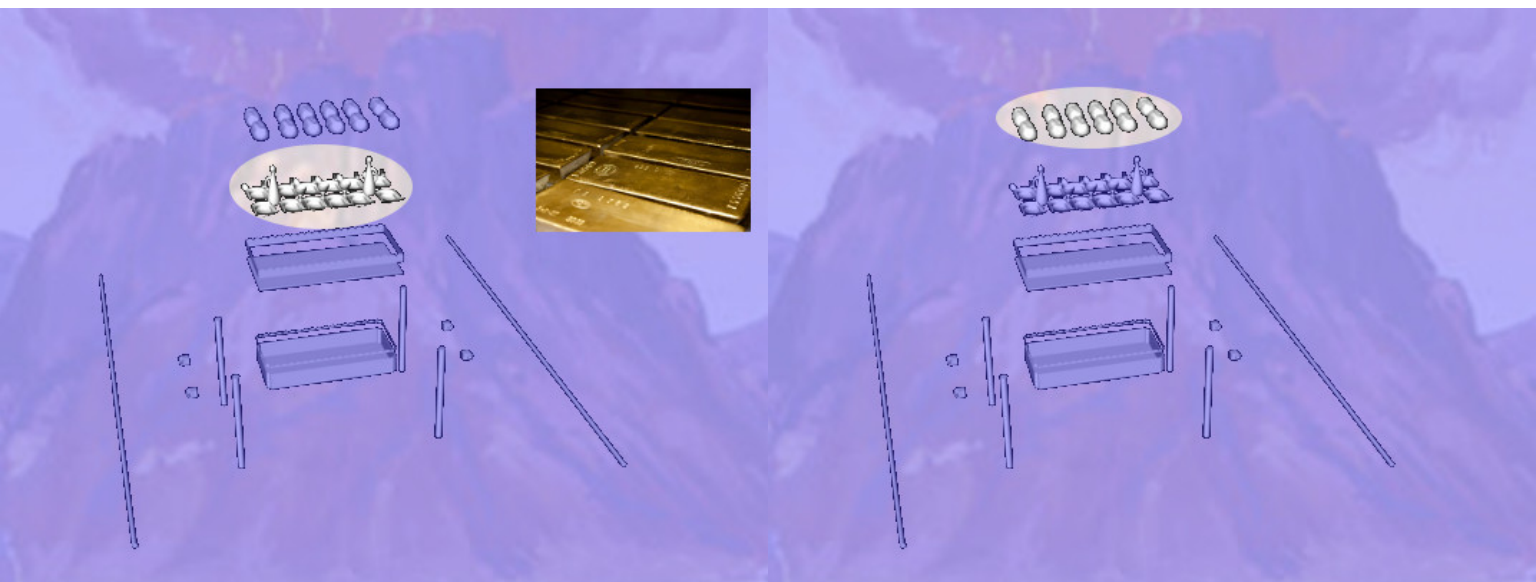

29 Harás también sus platos, cucharas, cubiertas y los tazones con que se libará; de oro fino los harás. Éxodo 25:29

30 Y pondrás siempre sobre la mesa el pan de la proposición delante de mí. Éxodo 25:30

98

99

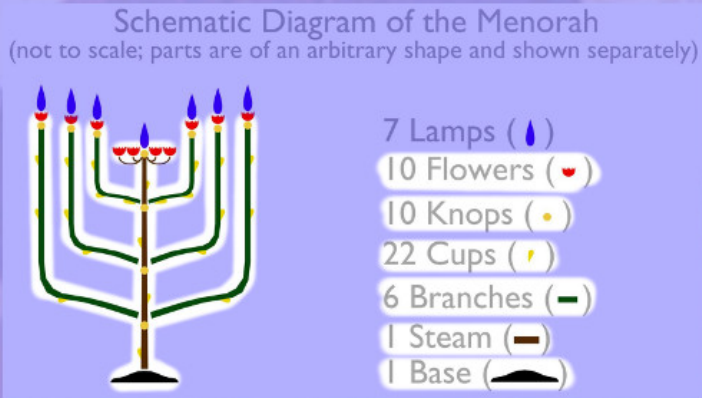

El candelabro de oro

31 >>Harás además un candelabro de oro puro; labrado a martillo se hará el candelabro; Éxodo 25 : 31a

su pie, su caña, sus copas, sus manzanas y sus flores serán de lo mismo. Éxodo 35 : 31b

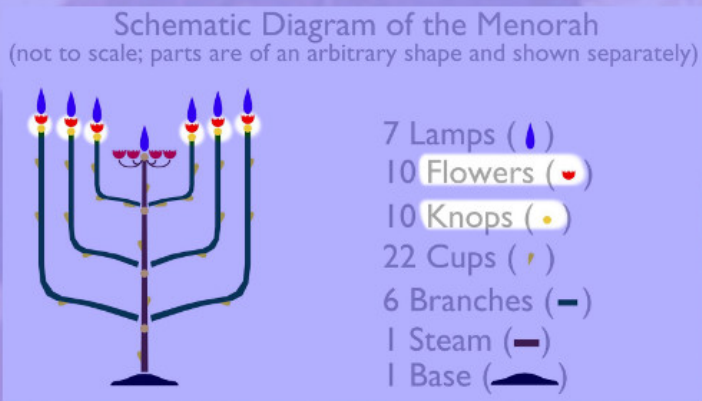
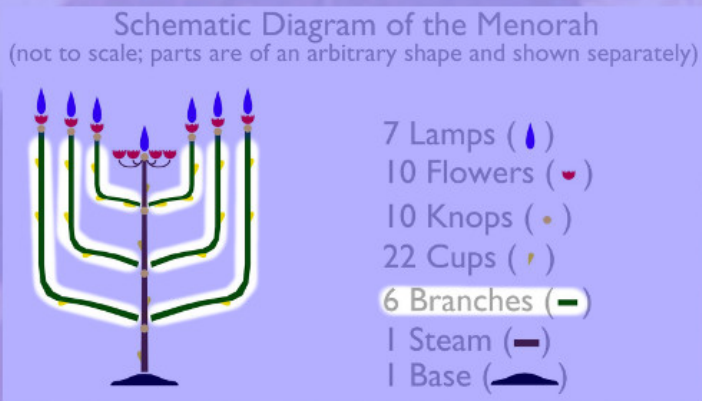

32 Y saldrán seis brazos de sus lados: tres brazos del candelabro a un lado y tres brazos al otro lado. Éxodo 25 : 32

33 Tres copas en forma de flor de almendro en un brazo, una manzana y una flor; y tres copas en forma de flor de almendro en otro brazo, una manzana y una flor; así en los seis brazos que salen del candelabro. Éxodo 25 : 33

Schematic Diagram of the Menorah
(not to scale; parts are of an arbitrary shape and shown separately)

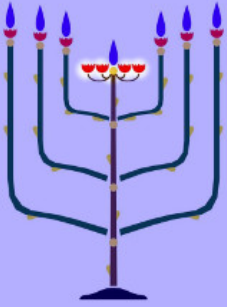

- 7 Lamps (♫)
- 10 Flowers (♥)
- 10 Knops (•)
- 22 Cups (♣)
- 6 Branches (—)
- 1 Stem (—)
- 1 Base (▾)

³⁴ En la caña central del candelabro habrá cuatro copas en forma de flor de almendro, sus manzanas y sus flores.
Éxodo 25 : 34

Schematic Diagram of the Menorah
(not to scale; parts are of an arbitrary shape and shown separately)

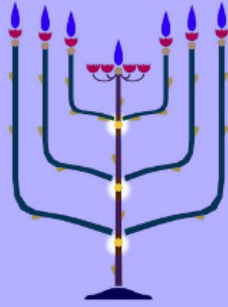

- 7 Lamps (♫)
- 10 Flowers (♥)
- 10 Knops (•)
- 22 Cups (♣)
- 6 Branches (—)
- 1 Stem (—)
- 1 Base (▾)

³⁵ Habrá una manzana debajo de dos brazos del mismo, otra manzana debajo de otros dos brazos del mismo y otra manzana debajo de los otros dos brazos del mismo; así para los seis brazos que salen del candelabro.
Éxodo 25 : 35

Schematic Diagram of the Menorah
(not to scale; parts are of an arbitrary shape and shown separately)



- 7 Lamps (♫)
- 10 Flowers (♥)
- 10 Knops (•)
- 22 Cups (♣)
- 6 Branches (—)
- 1 Stem (—)
- 1 Base (▾)

³⁶ Sus manzanas y sus brazos serán de una pieza, todo ello una pieza labrada a martillo, de oro puro. Éxodo 25 : 36

Schematic Diagram of the Menorah
(not to scale; parts are of an arbitrary shape and shown separately)



- 7 Lamps (♫)
- 10 Flowers (♥)
- 10 Knops (•)
- 22 Cups (♣)
- 6 Branches (—)
- 1 Stem (—)
- 1 Base (▾)

³⁷ Y le harás siete lámparas, las cuales encenderás para que alumbrén hacia adelante. Éxodo 25 : 37

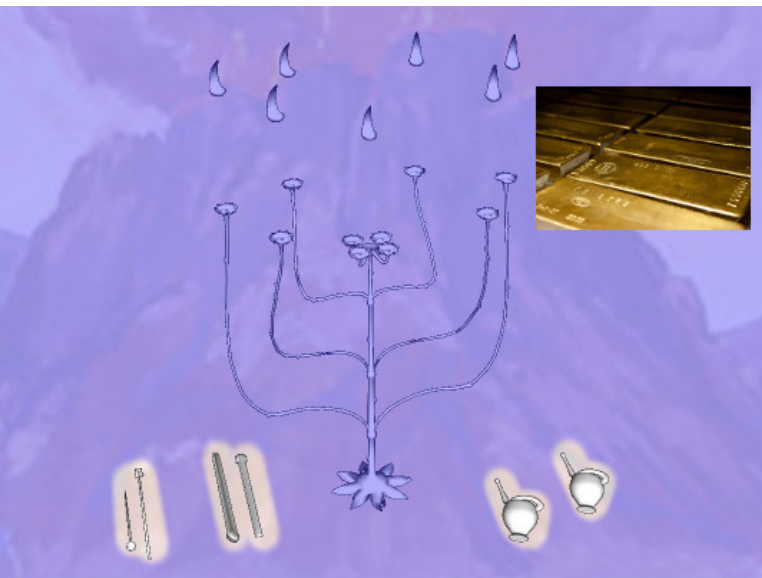

³⁸ También sus despabiladeras y sus platillos, de oro puro.
Éxodo 25:38

108

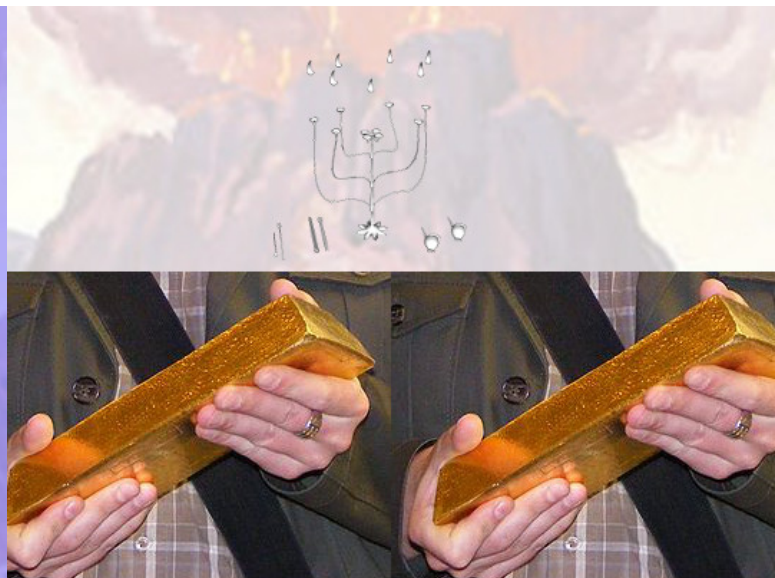

Good Delivery gold bar weighing 12.4 kg (400 troy ounces). One Egyptian talent was 27 kg (60 lb) So the Candlestick was made with approx. 2 of these bars. Price per Troy ounce is 1180 USD on June 30, 2015. Total value of the candlestick today is 944,000 USD

³⁹ De un talento de oro fino lo harás, con todos estos utensilios. ⁴⁰ Mira y hazlos conforme al modelo que te ha sido mostrado en el monte. Éxodo 25:39-40

109



Unit EG

Exodus 23-25

Bill and Shelley Houser
<http://www.ReadyAnswers.org>

Ark of the Covenant $2\frac{1}{2} \times 1\frac{1}{2} \times 1\frac{1}{2}$

Golden Altar of Incense $1 \times 1 \times 2$

Table of Showbread $2 \times 1 \times 1\frac{1}{2}$

Brazen Laver

Brazen Altar of Burnt Offerings $5 \times 5 \times 3$

The Veil

Golden Menorah

The Holy of Holies $10 \times 10 \times 10$

The Holy Place $10 \times 20 \times 10$

entrance

Gate 20 cubits

23-25

AveN

Scripture taken from the Louis Segond (LSG) translation.

1



Justice for All

Chapitre 23: ¹Tu ne répandras point de faux bruit.
Exode 23 : 1a

Tu ne te joindras point au méchant pour faire un faux témoignage.
Exode 23 : 1b



²Tu ne suivras point la multitude pour faire le mal;
Exode 23 : 2a

et tu ne déposeras point dans un procès en te mettant du côté du grand nombre, pour violer la justice.
Exode 23 : 2b

4

5



³Tu ne favoriseras point le pauvre dans son procès.
Exode 23 : 3

⁴Si tu rencontres le boeuf de ton ennemi ou son âne égaré, tu le lui ramèneras.
Exode 23 : 4

6

7



⁵ Si tu vois l'âne de ton ennemi succombant sous sa charge, et que tu hésites à le décharger, tu l'aideras à le décharger.
Exode 23 : 5

8



⁶ Tu ne porteras point atteinte au droit du pauvre dans son procès.
Exode 23 : 6

9

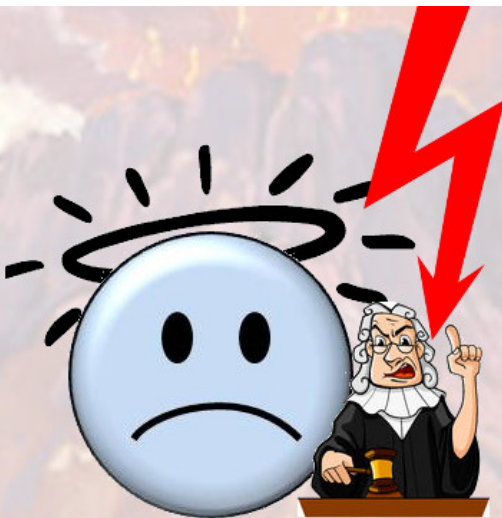

⁷ Tu ne prononceras point de sentence inique, et tu ne feras point mourir l'innocent et le juste; car je n'absoudrai point le coupable.
Exode 23 : 7

10



⁸ Tu ne recevras point de présent; car les présents aveuglent ceux qui ont les yeux ouverts et corrompent les paroles des justes.
Exode 23 : 8

11



The Law of Sabbaths

⁹Tu n'opprimeras point l'étranger; vous savez ce qu'éprouve l'étranger, car vous avez été étrangers dans le pays d'Égypte. Exode 23 : 9

12

¹⁰Pendant six années, tu ensemenceras la terre, et tu en recueilleras le produit. Exode 23 : 10

13

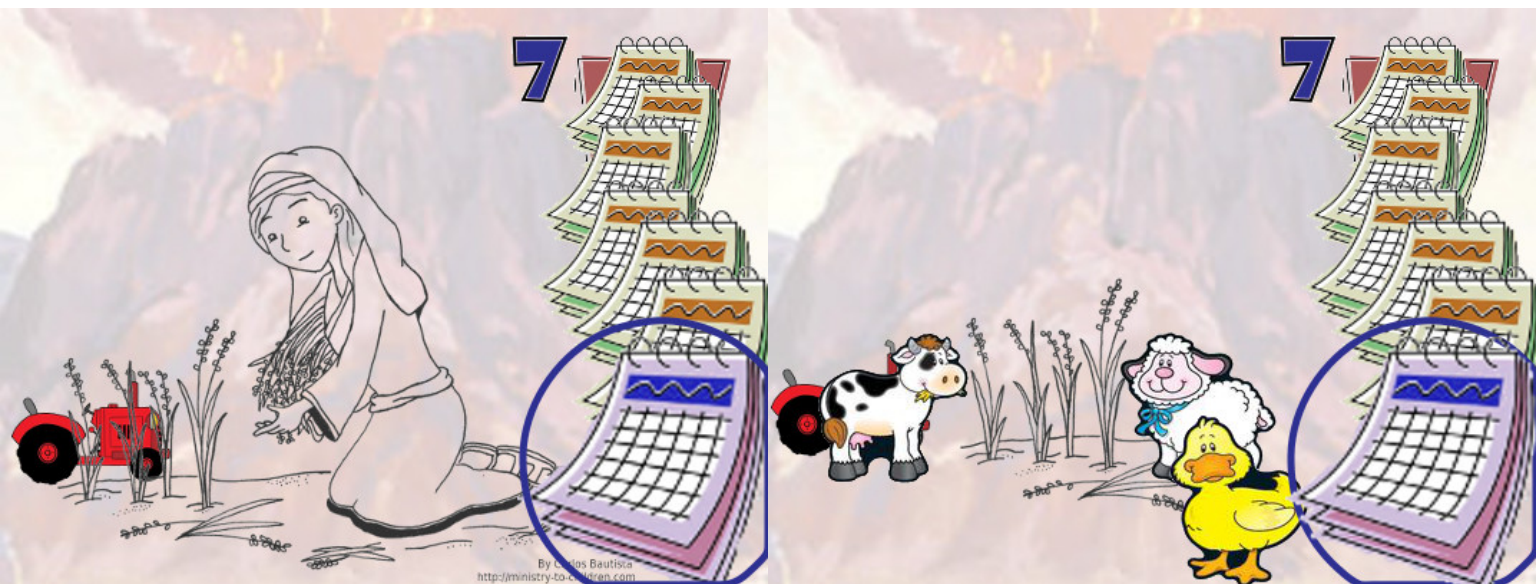

¹¹Mais la septième, tu lui donneras du relâche et tu la laisseras en repos; les pauvres de ton peuple en jouiront, Exode 23 : 11a

14

et les bêtes des champs mangeront ce qui restera. Exode 23 : 11b

15

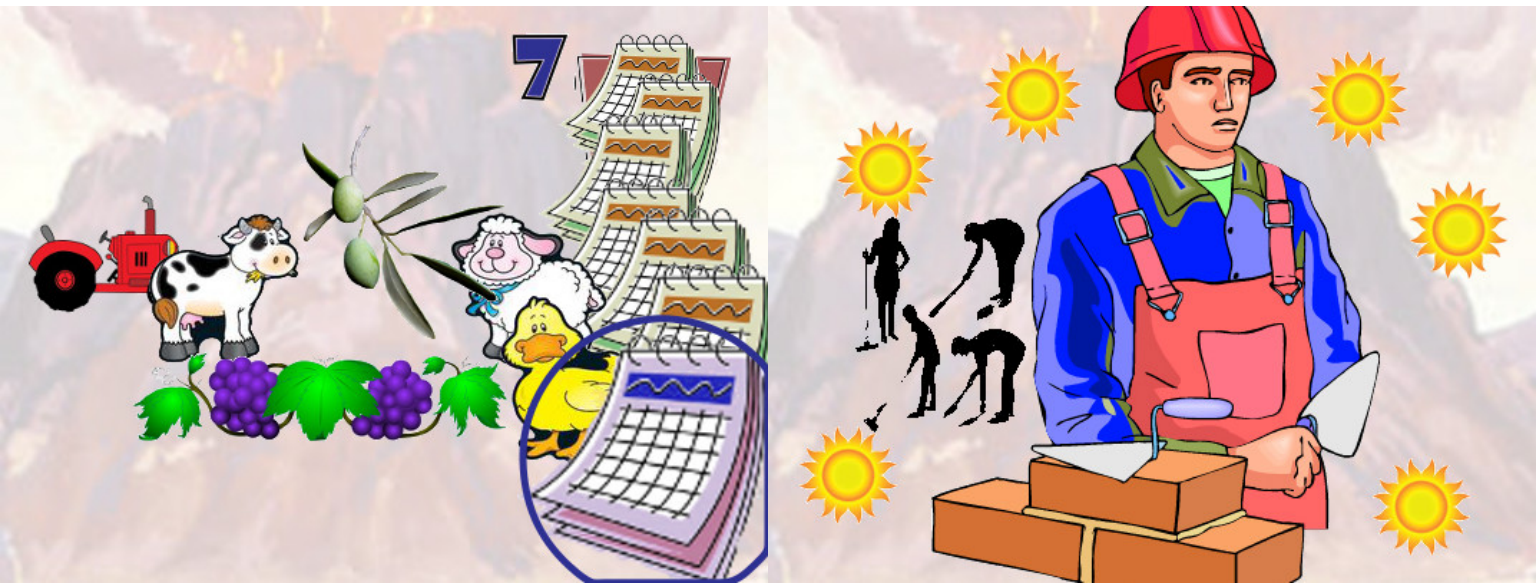

Tu feras de même pour ta vigne et pour tes oliviers.
Exode 23 : 11c

16

¹² Pendant six jours, tu feras ton ouvrage.
Exode 23 : 12a

17

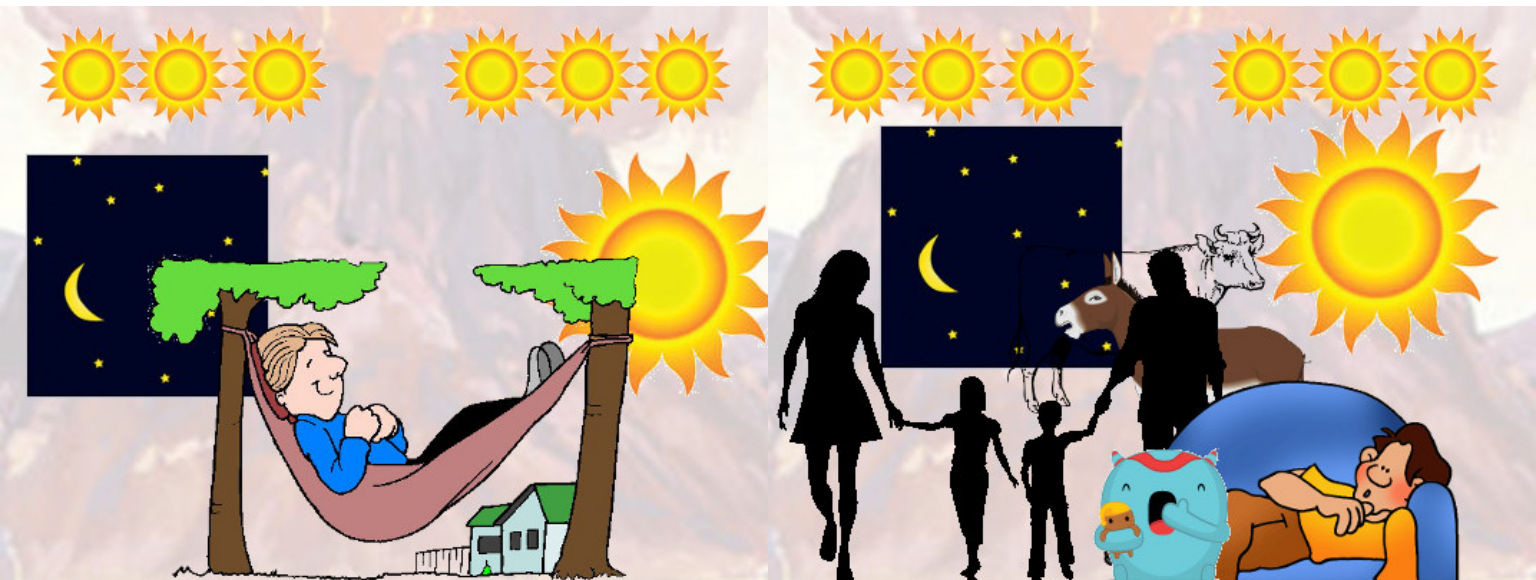

Mais le septième jour, tu te reposeras,
Exode 23 : 12b

18

afin que ton boeuf et ton âne aient du repos, afin que le
fils de ton esclave et l'étranger aient du relâche.
Exode 23 : 12c

19



Three Annual Feasts

¹³ Vous observerez tout ce que je vous ai dit, et vous ne prononcerez point le nom d'autres dieux: qu'on ne l'entende point sortir de votre bouche. Exode 23 : 13

¹⁴ Trois fois par année, tu célébreras des fêtes en mon honneur. Exode 23 : 14

20

21



¹⁵ Tu observeras la fête des pains sans levain; pendant sept jours, au temps fixé dans le mois des épis, tu mangeras des pains sans levain, comme je t'en ai donné l'ordre, car c'est dans ce mois que tu es sorti d'Égypte; et l'on ne se présentera point à vide devant ma face. Exode 23 : 15

¹⁶ Tu observeras la fête de la moisson, des prémices de ton travail, de ce que tu auras semé dans les champs; Exode 23 : 16a

22

23



et la fête de la récolte, à la fin de l'année, quand tu recueilleras des champs le fruit de ton travail.

Exode 23 : 16b

17 Trois fois par année, tous les mâles se présenteront devant le Seigneur, l'Éternel.

Exode 23 : 17

24

25



18 'Tu n'offriras point avec du pain levé le sang de la victime sacrifiée en mon honneur;

Exode 23 : 18a

et sa graisse ne sera point gardée pendant la nuit jusqu'au matin.

Exode 23 : 18b

26

27



¹⁹Tu apporteras à la maison de l'Éternel, ton Dieu, les prémices des premiers fruits de la terre. Exode 23 : 19a

Tu ne feras point cuire un chevreau dans le lait de sa mère. Exode 23 : 19b

28

29



The Angel and the Promises

²⁰Voici, j'envoie un ange devant toi, pour te protéger en chemin, et pour te faire arriver au lieu que j'ai préparé. Exode 23 : 20

²¹Tiens-toi sur tes gardes en sa présence, et écoute sa voix; Exode 23 : 21a

30

31



ne lui résiste point, parce qu'il ne pardonnera pas vos péchés, car mon nom est en lui. Exode 23 : 21b

²² Mais si tu écoutes sa voix, et si tu fais tout ce que je te dirai, Exode 23 : 22a

32

33



je serai l'ennemi de tes ennemis et l'adversaire de tes adversaires. Exode 23 : 22b

²³ Mon ange marchera devant toi, et te conduira chez les Amorcéens, les Héthiens, les Phéréziens, les Cananéens, les Héviens et les Jébusiens, et je les exterminerai.

Exode 23 : 23

34

35



24 Tu ne te prosterneras point devant leurs dieux, et tu ne les serviras point; tu n'imiteras point ces peuples dans leur conduite, mais tu les détruiras, et tu briseras leurs statues.
Exode 23 : 24

25 Vous servirez l'Éternel, votre Dieu, et il bénira votre pain et vos eaux,
Exode 23 : 25a

36

37



Deuteronomy 7:13-14 mention animals, too

et j'éloignerai la maladie du milieu de toi. Exode 23 : 25b

26 Il n'y aura dans ton pays ni femme qui avorte, ni femme stérile.
Exode 23 : 26a

38

39

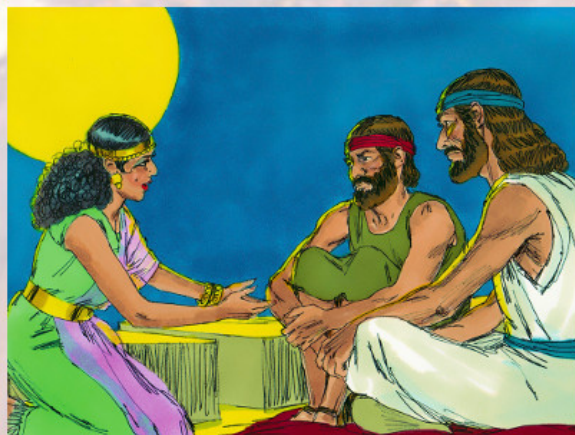

Rahab Told Spies Her People Were Afraid of the Israelites

Je remplirai le nombre de tes jours.

Exode 23 : 26b

40

27 J'enverrai ma terreur devant toi, je mettrai en déroute tous les peuples chez lesquels tu arriveras, et je ferai tourner le dos devant toi à tous tes ennemis.

Exode 23 : 27

41



28 J'enverrai les frelons devant toi, et ils chasseront loin de ta face les Héviens, les Cananéens et les Héthiens.

Exode 23 : 28

42

29 Je ne les chasserai pas en une seule année loin de ta face, de peur que le pays ne devienne un désert et que les bêtes des champs ne se multiplient contre toi.

Exode 23 : 29

43



30 Je les chasserai peu à peu loin de ta face, jusqu'à ce que tu augmentes en nombre et que tu puisses prendre possession du pays.
Exode 23 : 30

31 J'établirai tes limites depuis la mer Rouge jusqu'à la mer des Philistins, et depuis le désert jusqu'au fleuve; car je livrerai entre vos mains les habitants du pays, et tu les chasseras devant toi.
Exode 23 : 31

44

45



32 Tu ne feras point d'alliance avec eux, ni avec leurs dieux.
Exode 23 : 32

33 Ils n'habiteront point dans ton pays, de peur qu'ils ne te fassent pécher contre moi; car tu servirais leurs dieux, et ce serait un piège pour toi.
Exode 23 : 33

46

47



Picture used with permission: (c)2006 www.TheGloryStory.com

Israel Affirms the Covenant

Chapitre 24:¹Dieu dit à Moïse: Monte vers l'Éternel, toi et Aaron, Nadab et Abihu, et soixante-dix des anciens d'Israël, et vous vous prosternerez de loin. Exode 24:1

² Moïse s'approchera seul de l'Éternel; les autres ne s'approcheront pas, et le peuple ne montera point avec lui. Exode 24:2



³ Moïse vint rapporter au peuple toutes les paroles de l'Éternel et toutes les lois. Exode 24:3a

Le peuple entier répondit d'une même voix: Nous ferons tout ce que l'Éternel a dit. Exode 24:3b

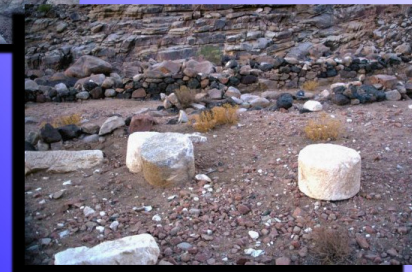
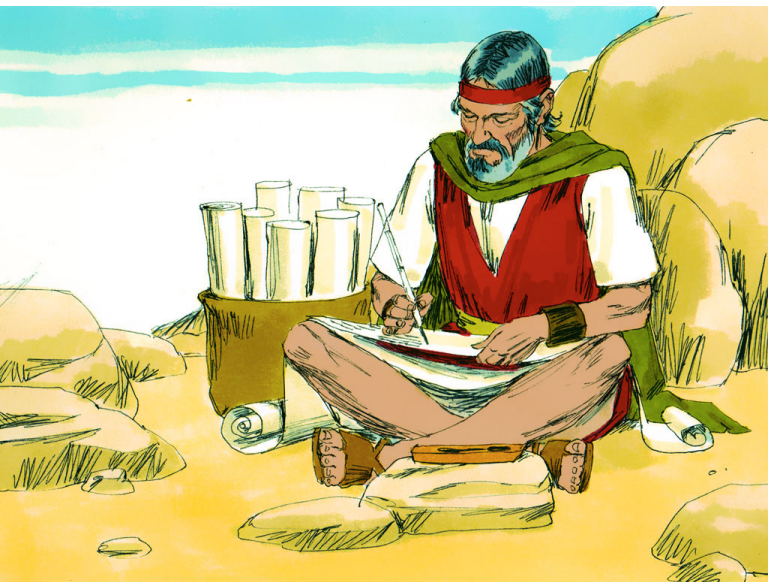

⁴Moïse écrivit toutes les paroles de l'Éternel.
Exode 24 : 4a

Puis il se leva de bon matin; il bâtit un autel au pied de la montagne, et dressa douze pierres pour les douze tribus d'Israël.
Exode 24 : 4b

52

53



⁵Il envoya des jeunes hommes, enfants d'Israël, pour offrir à l'Éternel des holocaustes, et immoler des taureaux en sacrifices d'actions de grâces.
Exode 24 : 5

⁶Moïse prit la moitié du sang, qu'il mit dans des bassins, et il répandit l'autre moitié sur l'autel.
Exode 24 : 6

54

55



⁷ Il prit le livre de l'alliance, et le lut en présence du peuple;
Exode 24 : 7a

ils dirent: Nous ferons tout ce que l'Éternel a dit, et nous obéirons.
Exode 24 : 7b

56

57



On the Mountain with God

⁸ Moïse prit le sang, et il le répandit sur le peuple, en disant:
Voici le sang de l'alliance que l'Éternel a faite avec vous
selon toutes ces paroles.
Exode 24 : 8

⁹ Moïse monta avec Aaron, Nadab et Abihu, et soixante-dix anciens d'Israël.¹⁰ Ils virent le Dieu d'Israël;
Exode 24 : 9-10a

58

59



Asous ses pieds, c'était comme un ouvrage de saphir transparent, comme le ciel lui-même dans sa pureté.

Exode 24 : 10b

¹¹ Il n'étendit point sa main sur l'élite des enfants d'Israël. Ils virent Dieu, et ils mangèrent et burent. Exode 24 : 11

60

61



¹² L'Éternel dit à Moïse: Monte vers moi sur la montagne, et reste là; je te donnerai des tables de pierre, la loi et les ordonnances que j'ai écrites pour leur instruction.

Exode 24 : 12



¹³ Moïse se leva, avec Josué qui le servait, et Moïse monta sur la montagne de Dieu.

Exode 24 : 13

62

63



¹⁴ Il dit aux anciens: Attendez-nous ici, jusqu'à ce que nous revenions auprès de vous. Voici, Aaron et Hur resteront avec vous; si quelqu'un a un différend, c'est à eux qu'il s'adressera.
Exode 24 : 14

64



Picture used with permission: (c)2006 www.TheGloryStory.com

¹⁵ Moïse monta sur la montagne, et la nuée couvrit la montagne.
Exode 24 : 15

65

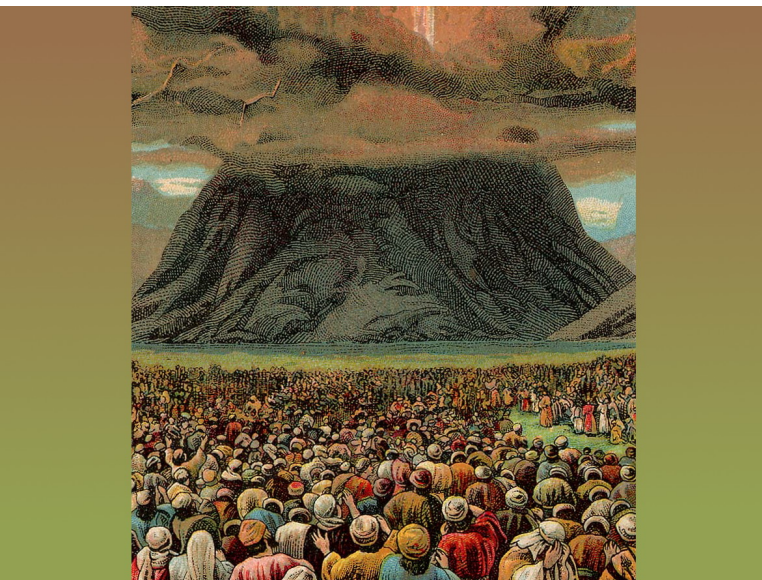

¹⁶ La gloire de l'Éternel reposa sur la montagne de Sinäi, et la nuée le couvrit pendant six jours. Le septième jour, l'Éternel appela Moïse du milieu de la nuée.
Exode 24 : 16

66



Picture used with permission: (c)2006 www.TheGloryStory.com

¹⁷ L'aspect de la gloire de l'Éternel était comme un feu dévorant sur le sommet de la montagne, aux yeux des enfants d'Israël.
Exode 24 : 17

67

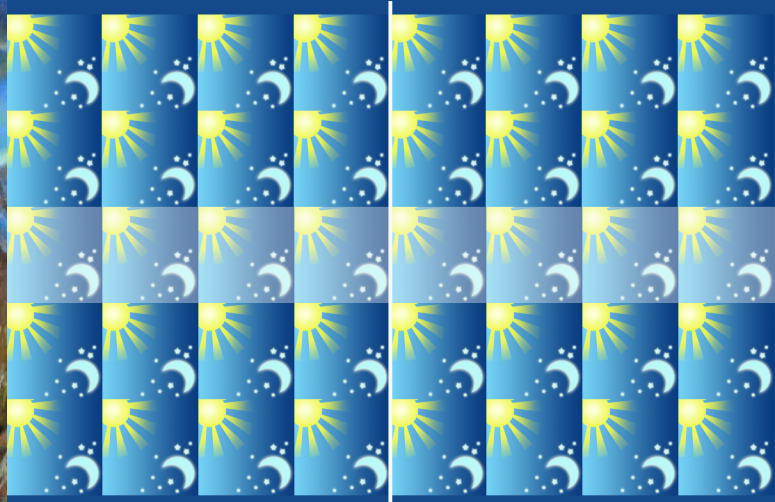

¹⁸ Moïse entra au milieu de la nuée, et il monta sur la montagne.
Exode 24 : 18a

Moïse demeura sur la montagne quarante jours et quarante nuits.
Exode 24 : 18b

68

69



Offerings for the Sanctuary

Chapitre 25: ¹L'Éternel parla à Moïse, et dit: ²Parle aux enfants d'Israël. Qu'ils m'apportent une offrande; vous la recevrez pour moi de tout homme qui la fera de bon coeur.
Exode 25 : 1-2

³ Voici ce que vous recevrez d'eux en offrande: de l'or, de l'argent et de l'airain;
Exode 25 : 3

70

71

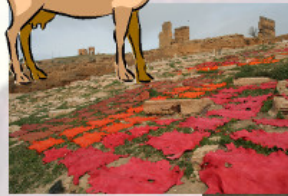

⁴des étoffes teintes en bleu, en pourpre, en cramoisi, du fin lin

Exode 25 : 4a

et du poil de chèvre; ⁵des peaux de béliers teintes en rouge et des peaux de dauphins; du bois d'acacia;

Exode 25 : 4b-5

72

73

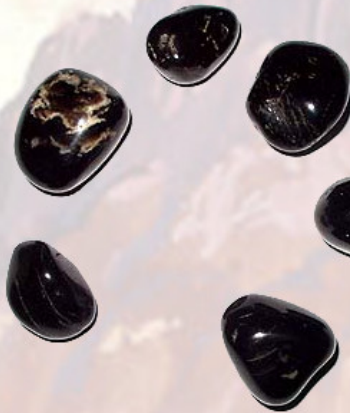

⁶de l'huile pour le chandelier, des aromates pour l'huile d'onction et pour le parfum odoriférant;

Exode 25 : 6

⁷des pierres d'onyx et d'autres pierres pour la garniture de l'éphod et du pectoral.

Exode 25 : 7

74

75

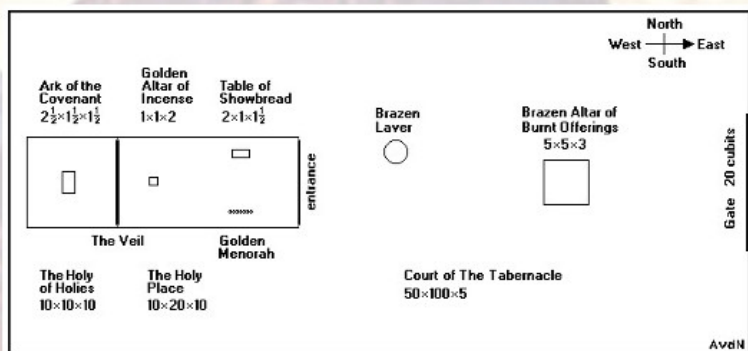

⁸ Ils me feront un sanctuaire, et j'habiterai au milieu d'eux.
Exode 25 : 8

⁹ Vous ferez le tabernacle et tous ses ustensiles d'après le modèle que je vais te montrer.
Exode 25 : 9

76

77

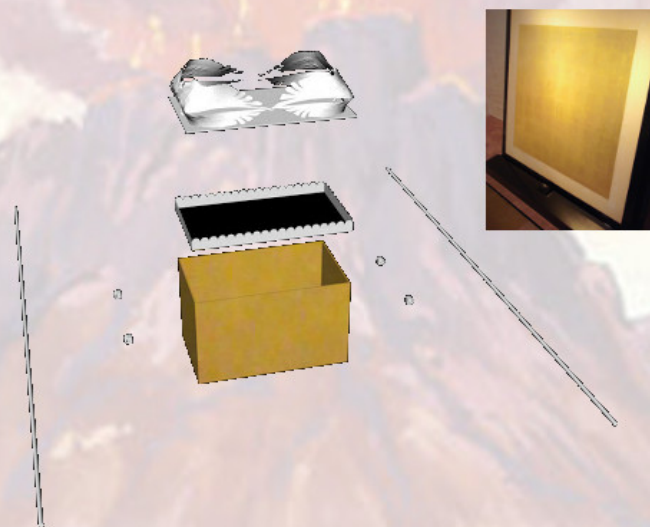
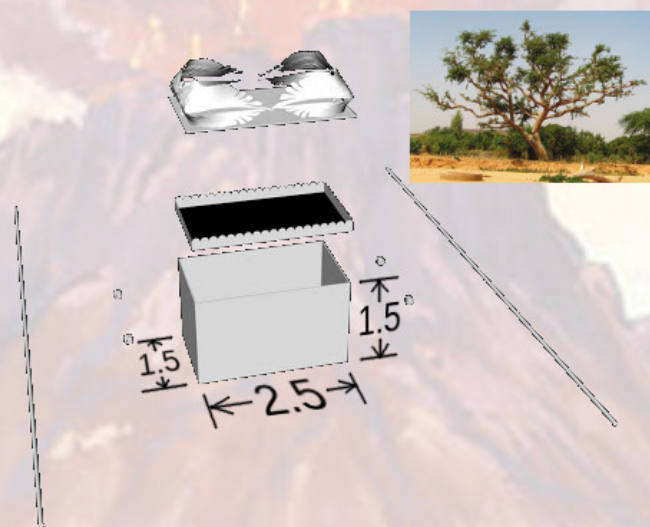

The Ark of the Testimony

¹⁰ Ils feront une arche de bois d'acacia, sa longueur sera de deux coudées et demie, sa largeur d'une coudée et demie, et sa hauteur d'une coudée et demie.
Exode 25 : 10

¹¹ Tu la couvriras d'or pur, tu la couvriras en dedans et en dehors,
Exode 25 : 11a

78

79



et tu y feras une bordure d'or tout autour.

Exode 25 : 11b

¹²Tu fondras pour elle quatre anneaux d'or, et tu les mettras à ses quatre coins, deux anneaux d'un côté et deux anneaux de l'autre côté.

Exode 25 : 12

80

81



¹³Tu feras des barres de bois d'acacia, et tu les couvriras d'or.

Exode 25 : 13

¹⁴Tu passeras les barres dans les anneaux sur les côtés de l'arche, pour qu'elles servent à porter l'arche; ¹⁵Tes barres resteront dans les anneaux de l'arche, et n'en seront point retirées.

Exode 25 : 14-15

82

83

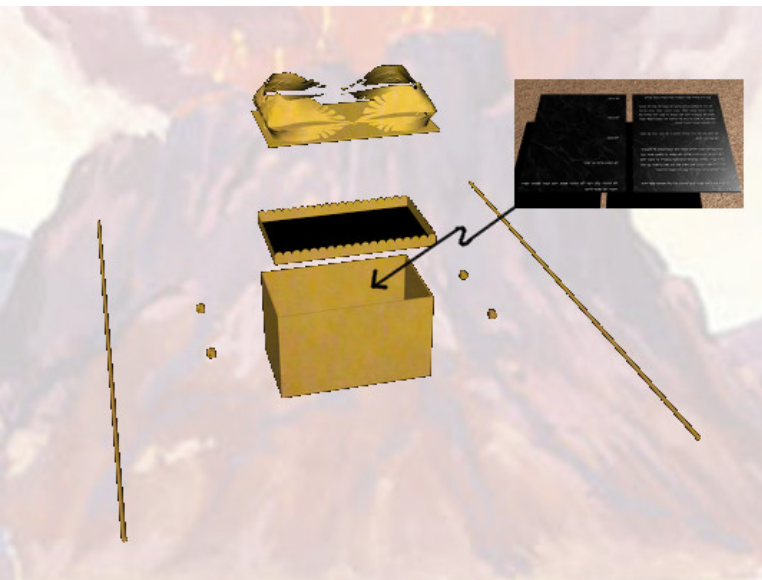

16 Tu mettras dans l'arche le témoignage, que je te donnerai.

Exode 25 : 16

84

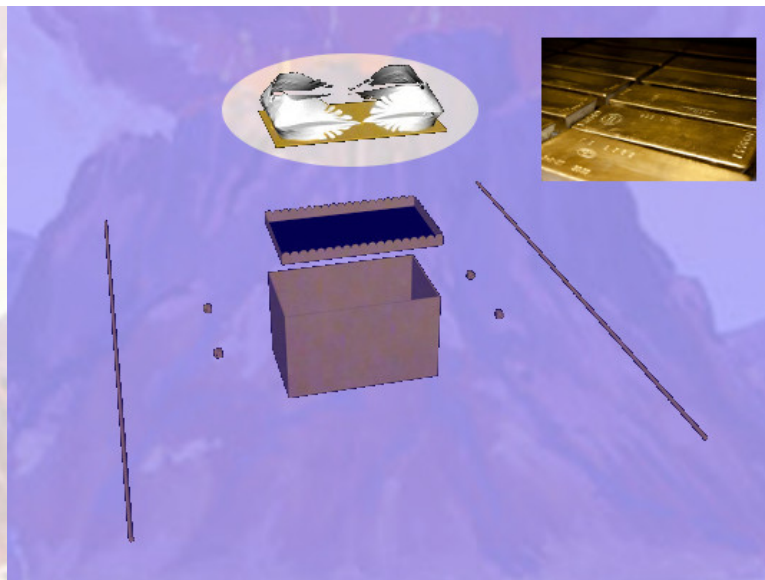

17 Tu feras un propitiatoire d'or pur; sa longueur sera de deux coudées et demie, et sa largeur d'une coudée et demie.

Exode 25 : 17

85

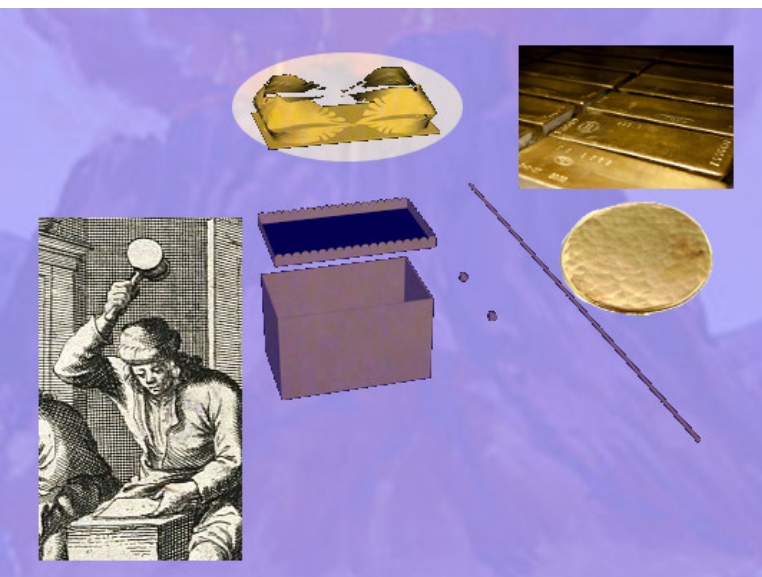

Ezekiel 1 and 10 describe beasts that are called cherubim that look like this.

18 Tu feras deux chérubins d'or, tu les feras d'or battu, aux deux extrémités du propitiatoire;

Exode 25 : 18

86

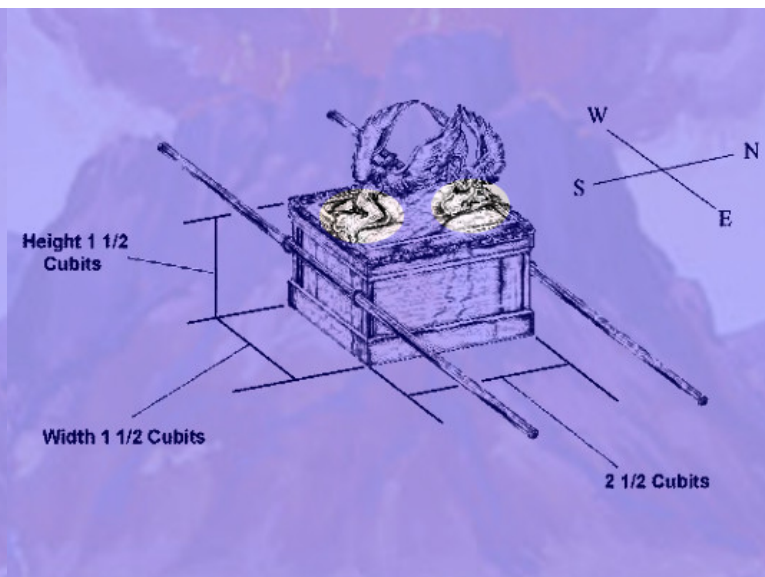

19 fais un chérubin à l'une des extrémités et un chérubin à l'autre extrémité; vous ferez les chérubins sortant du propitiatoire à ses deux extrémités.

Exode 25 : 19

87

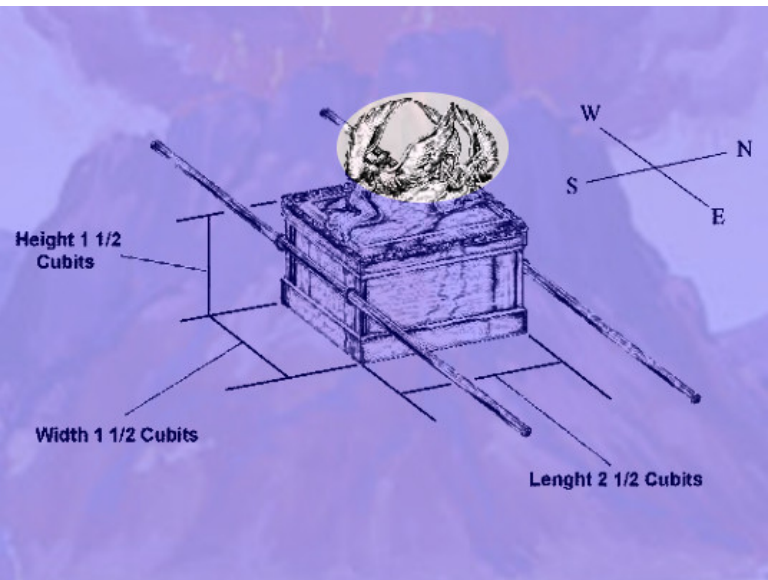

²⁰ Les chérubins étendront les ailes par-dessus, couvrant de leurs ailes le propitiatoire, et se faisant face l'un à l'autre; les chérubins auront la face tournée vers le propitiatoire.
Exode 25 : 20

88

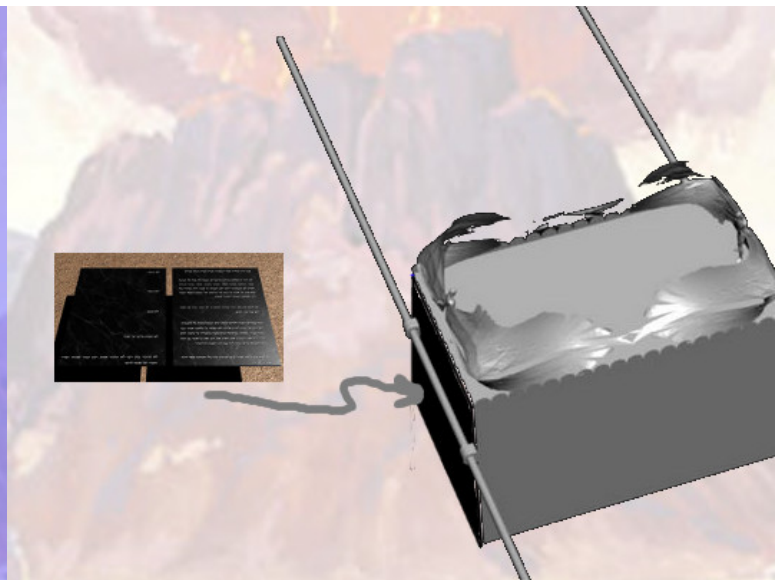

²¹ Tu mettras le propitiatoire sur l'arche, et tu mettras dans l'arche le témoignage, que je te donnerai.

Exode 25 : 21

89

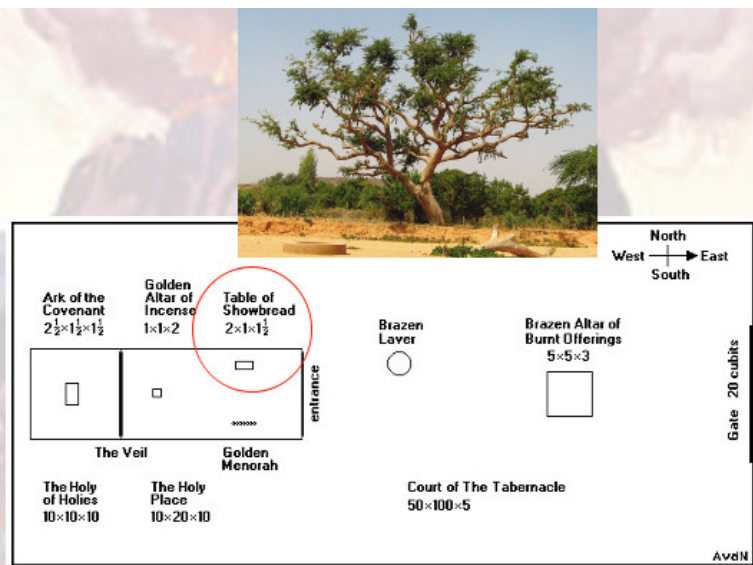
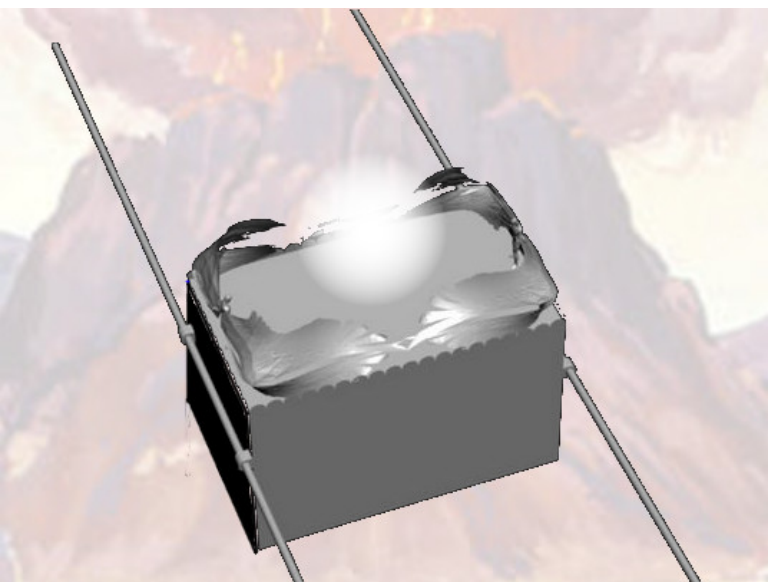

The Table for the Showbread

²² C'est là que je me rencontrerai avec toi; du haut du propitiatoire, entre les deux chérubins placés sur l'arche du témoignage, je te donnerai tous mes ordres pour les enfants d'Israël.
Exode 25 : 22

90

²³ Tu feras une table de bois d'acacia; sa longueur sera de deux coudées, sa largeur d'une coudée, et sa hauteur d'une coudée et demie.

Exode 25 : 23

91

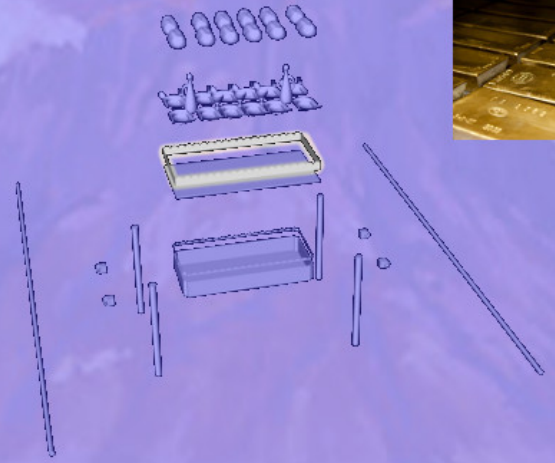
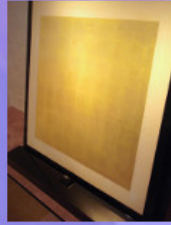
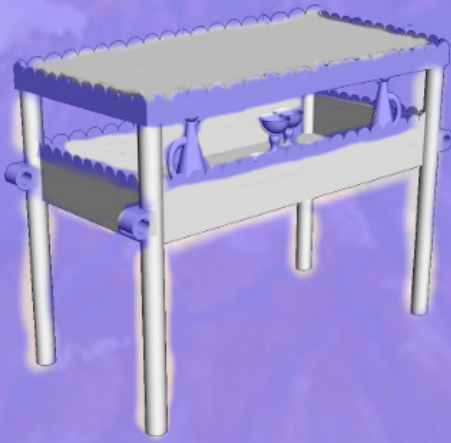

24 Tu la couvriras d'or pur,

Exode 25 : 24a

et tu y feras une bordure d'or tout autour.

Exode 25 : 24b

92

93

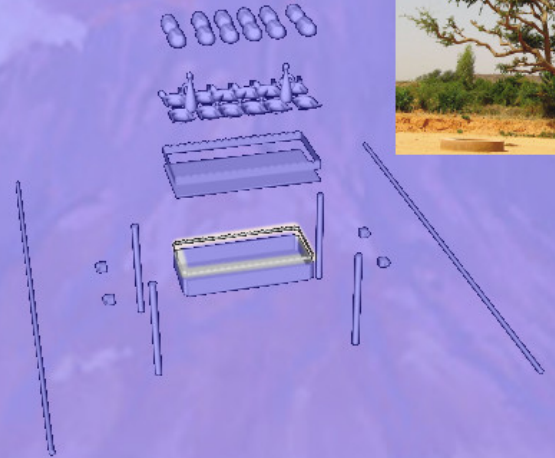
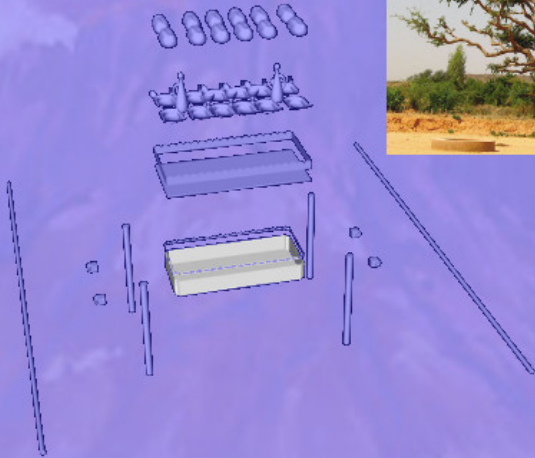

25 Tu y feras à l'entour un rebord de quatre doigts,

Exode 25 : 25a

sur lequel tu mettras une bordure d'or tout autour.

Exode 25 : 25b

94

95



²⁶ Tu feras pour la table quatre anneaux d'or, et tu mettras les anneaux aux quatre coins, qui seront à ses quatre pieds.
²⁷ Les anneaux seront près du rebord, et recevront les barres pour porter la table.
 Exode 25 : 26-27

96

²⁸ Tu feras les barres de bois d'acacia, et tu les couvriras d'or; et elles serviront à porter la table. Exode 25 : 28

97



²⁹ Tu feras ses plats, ses coupes, ses calices et ses tasses, pour servir aux libations; tu les feras d'or pur.
 Exode 25 : 29

98

³⁰ Tu mettras sur la table les pains de proposition continuellement devant ma face.

Exode 25 : 30

99



The Gold Lampstand

³¹Tu feras un chandelier d'or pur; ce chandelier sera fait d'or battu; Exode 25 : 31a

Schematic Diagram of the Menorah (not to scale; parts are of an arbitrary shape and shown separately)

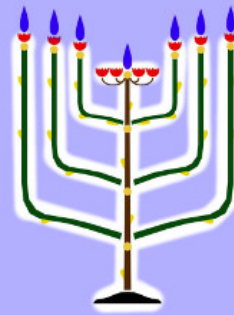

- 7 Lamps (♫)
- 10 Flowers (♥)
- 10 Knops (•)
- 22 Cups (♪)
- 6 Branches (—)
- 1 Steam (—)
- 1 Base (▴)

son pied, sa tige, ses calices, ses pommes et ses fleurs seront d'une même pièce. Exode 35 : 31b

Schematic Diagram of the Menorah

(not to scale; parts are of an arbitrary shape and shown separately)

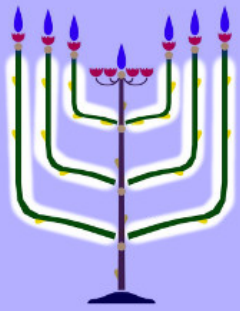

- 7 Lamps (♫)
- 10 Flowers (♥)
- 10 Knops (•)
- 22 Cups (♪)
- 6 Branches (—)
- 1 Steam (—)
- 1 Base (▴)

³²Six branches sortiront de ses côtés, trois branches du chandelier de l'un des côtés, et trois branches du chandelier de l'autre côté. Exode 25 : 32

Schematic Diagram of the Menorah

(not to scale; parts are of an arbitrary shape and shown separately)

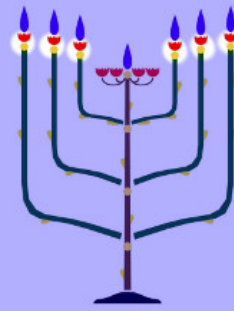

- 7 Lamps (♫)
- 10 Flowers (♥)
- 10 Knops (•)
- 22 Cups (♪)
- 6 Branches (—)
- 1 Steam (—)
- 1 Base (▴)

³³Il y aura sur une branche trois calices en forme d'amande, avec pommes et fleurs, et sur une autre branche trois calices en forme d'amande, avec pommes et fleurs; il en sera de même pour les six branches sortant du chandelier. Exode 25 : 33

Schematic Diagram of the Menorah
(not to scale; parts are of an arbitrary shape and shown separately)

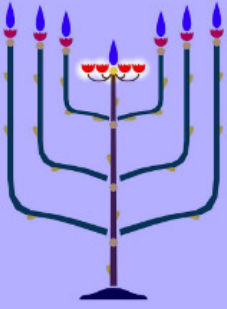

- 7 Lamps (♯)
- 10 Flowers (♥)
- 10 Knops (•)
- 22 Cups (♣)
- 6 Branches (—)
- 1 Stem (—)
- 1 Base (—)

³⁴ A la tige du chandelier, il y aura quatre calices en forme d'amande, avec leurs pommes et leurs fleurs.

Exode 25 : 34

Schematic Diagram of the Menorah
(not to scale; parts are of an arbitrary shape and shown separately)

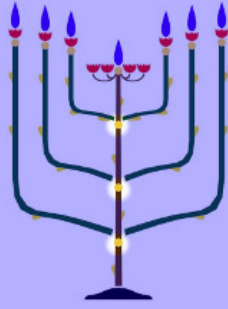

- 7 Lamps (♯)
- 10 Flowers (♥)
- 10 Knops (•)
- 22 Cups (♣)
- 6 Branches (—)
- 1 Stem (—)
- 1 Base (—)

³⁵ Il y aura une pomme sous deux des branches sortant de la tige du chandelier, une pomme sous deux autres branches, et une pomme sous deux autres branches; il en sera de même pour les six branches sortant du chandelier.

Exode 25 : 35

Schematic Diagram of the Menorah
(not to scale; parts are of an arbitrary shape and shown separately)

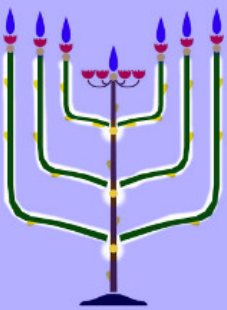

- 7 Lamps (♯)
- 10 Flowers (♥)
- 10 Knops (•)
- 22 Cups (♣)
- 6 Branches (—)
- 1 Stem (—)
- 1 Base (—)

³⁶ Les pommes et les branches du chandelier seront d'une même pièce: il sera tout entier d'or battu, d'or pur.

Exode 25 : 36

Schematic Diagram of the Menorah
(not to scale; parts are of an arbitrary shape and shown separately)



- 7 Lamps (♯)
- 10 Flowers (♥)
- 10 Knops (•)
- 22 Cups (♣)
- 6 Branches (—)
- 1 Stem (—)
- 1 Base (—)

³⁷ Tu feras ses sept lampes, qui seront placées dessus, de manière à éclairer en face.

Exode 25 : 37

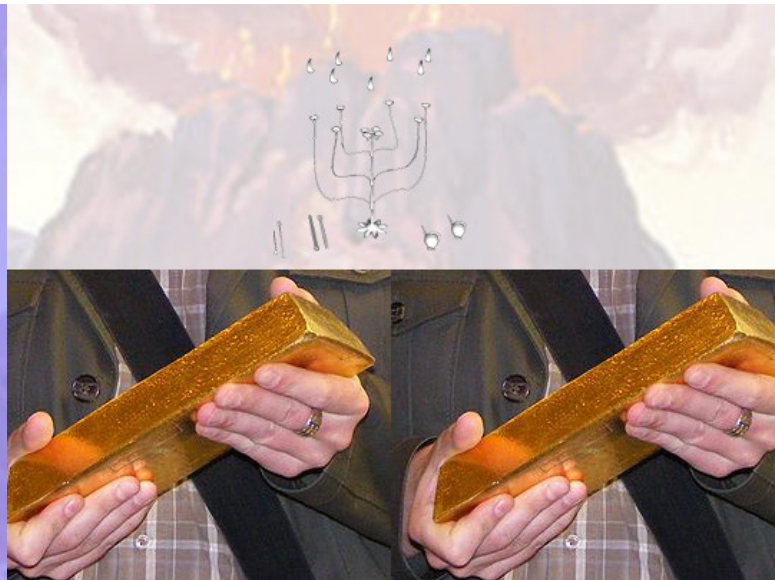

³⁸Ses mouchettes et ses vases à cendre seront d'or pur.
Exode 25:38

108

Good Delivery gold bar weighing 12.4 kg (400 troy ounces). One Egyptian talent was 27 kg (60 lb) So the Candlestick was made with approx. 2 of these bars. Price per Troy ounce is 1180 USD on June 30, 2015. Total value of the candlestick today is 944,000 USD

³⁹On emploiera un talent d'or pur pour faire le chandelier avec tous ses ustensiles. ⁴⁰Regarde, et fais d'après le modèle qui t'est montré sur la montagne.

109

Exode 25:39-40

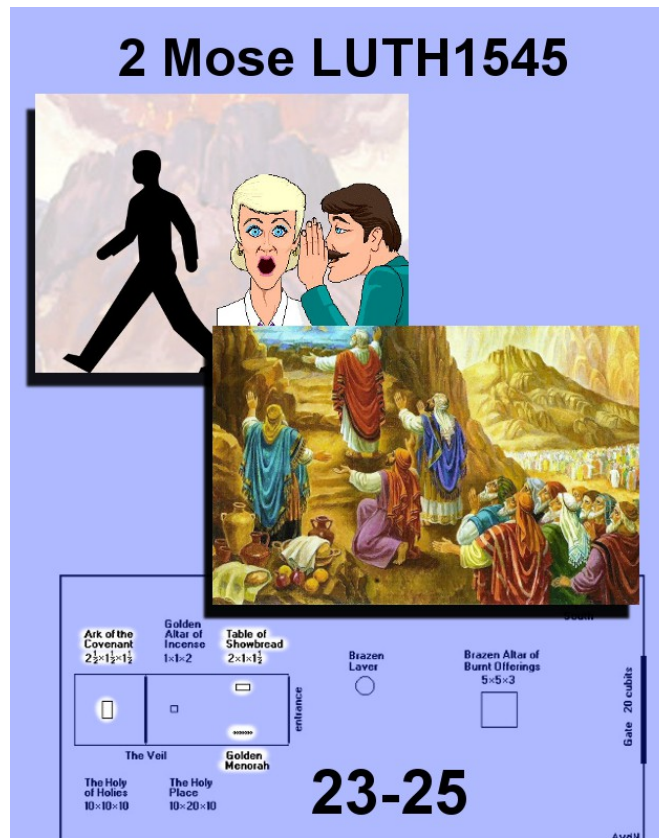

2 Mose 23

1 Du sollst falscher Anklage nicht glauben, daß du einem Gottlosen Beistand tust und ein falscher Zeuge seist.

2 Du sollst nicht folgen der Menge zum Bösen und nicht also verantworten vor Gericht, daß du der Menge nach vom Rechten weichst.

3 Du sollst den Geringen nicht beschönigen in seiner Sache.

4 Wenn du deines Feindes Ochsen oder Esel begegnest, daß er irrt, so sollst du ihm denselben wieder zuführen.

5 Wenn du den Esel des, der dich haßt, siehst unter seiner Last liegen, hüte dich, und laß ihn nicht, sondern versäume gerne das Deine um seinetwillen.

6 Du sollst das Recht deines Armen nicht beugen in seiner Sache.

7 Sei ferne von falschen Sachen. Den Unschuldigen und Gerechten sollst du nicht erwürgen; denn ich lasse den Gottlosen nicht Recht haben.

8 Du sollst nicht Geschenke nehmen; denn Geschenke machen die Sehenden blind und verkehren die Sachen der Gerechten.

9 Die Fremdlinge sollt ihr nicht unterdrücken; denn ihr wisset um der Fremdlinge Herz, dieweil ihr auch seid Fremdlinge in Ägyptenland gewesen.

10 Sechs Jahre sollst du dein Land besäen und seine Früchte einsammeln.

11 Im siebenten Jahr sollst du es ruhen und liegen lassen, daß die Armen unter deinem Volk davon essen; und was übrigbleibt, laß das Wild auf dem Felde essen. Also sollst du auch tun mit deinem Weinberg und Ölberg.

12 Sechs Tage sollst du deine Arbeit tun; aber des siebenten Tages sollst du feiern, auf daß dein Ochs und Esel ruhen und deiner Magd Sohn und der Fremdling sich erquicken.

13 Alles, was ich euch gesagt habe, das haltet. Und anderer Götter Namen sollt ihr nicht gedenken, und aus eurem Munde sollen sie nicht gehört werden.

14 Dreimal sollt ihr mir Feste halten im Jahr:

15 das Fest der ungesäuerten Brote sollst du halten, daß du sieben Tage ungesäuertes Brot essest, wie ich dir geboten habe, um die Zeit des Monats Abib; denn in demselben bist du aus Ägypten gezogen. Erscheint aber nicht leer vor mir.

16 Und das Fest der Ernte, der Erstlinge deiner Früchte, die du auf dem Felde gesät hast. Und das Fest der Einsammlung im Ausgang des Jahres, wenn du deine Arbeit eingesammelt hast vom Felde.

17 Dreimal im Jahre soll erscheinen vor dem HERRN, dem Herrscher, alles, was männlich ist unter dir.

18 Du sollst das Blut meines Opfers nicht neben dem Sauerteig opfern, und das Fett von meinem Fest soll nicht bleiben bis auf morgen.

19 Die Erstlinge von der ersten Frucht auf deinem Felde sollst du bringen in das Haus des HERRN, deines Gottes. Und sollst das Böcklein nicht kochen in seiner Mutter Milch.

20 Siehe, ich sende einen Engel vor dir her, der dich behüte auf dem Wege und bringe dich an den Ort, den ich bereitet habe.

21 Darum hüte dich vor seinem Angesicht und gehorche seiner Stimme und erbittere ihn nicht; denn er wird euer Übertreten nicht vergeben, und mein Name ist in ihm.

22 Wirst du aber seiner Stimme hören und tun alles, was ich dir sagen werde, so will ich deiner Feinde Feind und deiner Widersacher Widersacher sein.

23 Wenn nun mein Engel vor dir her geht und dich bringt an die Amoriter, Hethiter, Pheresiter, Kanaaniter, Heviter und Jebusiter und ich sie vertilge,

24 so sollst du ihre Götter nicht anbeten noch ihnen dienen und nicht tun, wie sie tun, sondern du sollst ihre Götzen umreißen und zerbrechen.

25 Aber dem HERRN, eurem Gott, sollt ihr dienen, so wird er dein Brot und dein Wasser segnen, und ich will alle Krankheit von dir wenden.

26 Es soll nichts Unträchtiges noch Unfruchtbares sein in deinem Lande, und ich will dich lassen alt werden.

27 Ich will meinen Schrecken vor dir her senden und alles Volk verzagt machen, dahin du kommst, und will dir alle deine Feinde in die Flucht geben.

28 Ich will Hornissen vor dir her senden, die vor dir her ausjagen die Heviter, Kanaaniter und Hethiter.

29 Ich will sie nicht auf ein Jahr ausstoßen vor dir, auf daß nicht das Land wüst werde und sich wilde Tiere wider dich mehren;

30 einzeln nacheinander will ich sie vor dir her ausstoßen, bis du wächsest und das Land besitzest.

31 Und will deine Grenze setzen von dem Schilfmeer bis an das Philistermeer und von der Wüste bis an den Strom. Denn ich will dir in deine Hand geben die Einwohner des Landes, daß du sie sollst ausstoßen vor dir her.

32 Du sollst mit ihnen oder mit ihren Göttern keinen Bund machen;

33 sondern laß sie nicht wohnen in deinem Lande, daß sie dich nicht verführen wider mich. Denn wo du ihren Göttern dienst, wird dir's zum Fall geraten.

2 Mose 24

1 Und zu Mose sprach er: Steig herauf zum HERRN, du und Aaron, Nadab und Abihu und siebenzig von den Ältesten Israels, und betet an von ferne.

2 Aber Mose allein nahe sich zum HERRN und lasse jene nicht herzu nahen, und das Volk komme auch nicht zu ihm herauf.

3 Mose kam und erzählte dem Volk alle Worte des HERRN und alle Rechte. Da antwortete alles Volk mit einer Stimme und sprachen: Alle Worte, die der HERR gesagt hat, wollen wir tun.

4 Da schrieb Mose alle Worte des HERRN und machte sich des Morgens früh auf und baute einen Altar unten am Berge mit zwölf Säulen nach den zwölf Stämmen Israels,

5 und sandte hin Jünglinge aus den Kindern Israel, daß sie Brandopfer darauf opferten und Dankopfer dem HERRN von Farren.

6 Und Mose nahm die Hälfte des Blutes und tat's in ein Becken, die andere Hälfte sprengte er auf den Altar.

7 Und nahm das Buch des Bundes und las es vor den Ohren des Volkes. Und da sie sprachen: Alles, was der HERR gesagt hat, das wollen wir tun und gehorchen,

8 da nahm Mose das Blut und besprengte das Volk damit und sprach: Sehet, das ist das Blut des Bundes, den der HERR mit euch macht über allen diesen Worten.

9 Da stiegen Mose und Aaron, Nadab und Abihu und siebenzig von den Ältesten Israels hinauf

10 und sahen den Gott Israels. Unter seinen Füßen war es wie ein schöner Saphir und wie die Gestalt des Himmels, wenn's klar ist.

11 Und er reckte seine Hand nicht aus wider die Obersten in Israel. Und da sie Gott geschaut hatten, aßen und tranken sie.

12 Und der HERR sprach zu Mose: Komm herauf zu mir auf den Berg und bleib daselbst, daß ich dir gebe steinerne Tafeln und Gesetze und Gebote, die ich geschrieben habe, die du sie lehren sollst.

13 Da machte sich Mose auf mit seinem Diener Josua und stieg auf den Berg Gottes

14 und sprach zu den Ältesten: Bleibet hier, bis wir wieder zu euch kommen. Siehe, Aaron und Hur sind bei euch; hat jemand eine Sache, der komme vor dieselben.

15 Da nun Mose auf den Berg kam, bedeckte eine Wolke den Berg,

16 und die Herrlichkeit des HERRN wohnte auf dem Berge Sinai und deckte ihn mit der Wolke sechs Tage, und er rief Mose am siebenten Tage aus der Wolke.

17 Und das Ansehen der Herrlichkeit des HERRN war wie ein verzehrendes Feuer auf der Spitze des

Berges vor den Kindern Israel.

18 Und Mose ging mitten in die Wolke und stieg auf den Berg und blieb auf dem Berg vierzig Tage und vierzig Nächte.

2 Mose 25

1 Und der HERR redete mit Mose und sprach:

2 Sage den Kindern Israel, daß sie mir ein Hebopfer geben; und nehmt dasselbe von jedermann, der es willig gibt.

3 Das ist aber das Hebopfer, das ihr von ihnen nehmen sollt: Gold, Silber, Erz,

4 blauer und roter Purpur, Scharlach, köstliche weiße Leinwand, Ziegenhaar,

5 rötliche Widderfelle, Dachsfelle, Akazienholz,

6 Öl zur Lampe, Spezerei zur Salbe und zu gutem Räuchwerk,

7 Onyxsteine und eingefaßte Steine zum Leibrock und zum Amtschild.

8 Und sie sollen mir ein Heiligtum machen, daß ich unter ihnen wohne.

9 Wie ich dir ein Vorbild der Wohnung und alles ihres Geräts zeigen werde, so sollt ihr's machen.

10 Macht eine Lade aus Akazienholz; dritthalb Ellen soll die Länge sein, anderthalb Ellen die Breite und anderthalb Ellen die Höhe.

11 Du sollst sie mit Gold überziehen inwendig und auswendig, und mache einen goldenen Kranz oben umher.

12 Und gieße vier goldene Ringe und mache sie an ihr vier Ecken, also daß zwei Ringe seien auf einer Seite und zwei auf der andern Seite.

13 Und mache Stangen von Akazienholz und überziehe sie mit Gold

14 und stecke sie in die Ringe an der Lade Seiten, daß man sie damit trage;

15 sie sollen in den Ringen bleiben und nicht herausgetan werden.

16 Und sollst in die Lade das Zeugnis legen, das ich dir geben werde.

17 Du sollst auch einen Gnadenstuhl machen von feinem Golde; dritthalb Ellen soll seine Länge sein und anderthalb Ellen seine Breite.

18 Und du sollst zwei Cherubim machen von getriebenem Golde zu beiden Enden des Gnadenstuhls,

19 daß ein Cherub sei an diesem Ende, der andere an dem andern Ende, und also zwei Cherubim seien an des Gnadenstuhls Enden.

20 Und die Cherubim sollen ihr Flügel ausbreiten von oben her, daß sie mit ihren Flügeln den Gnadenstuhl bedecken und eines jeglichen Antlitz gegen das des andern stehe; und ihre Antlitze sollen auf den Gnadenstuhl sehen.

21 Und sollst den Gnadenstuhl oben auf die Lade tun und in die Lade das Zeugnis legen, das ich dir geben werde.

22 Von dem Ort will ich mich dir bezeugen und mit dir reden, nämlich von dem Gnadenstuhl zwischen den zwei Cherubim, der auf der Lade des Zeugnisses ist, alles, was ich dir gebieten will an die Kinder

Israel.

23 Du sollst auch einen Tisch machen von Akazienholz; zwei Ellen soll seine Länge sein und eine Elle sein Breite und anderthalb Ellen seine Höhe.

24 Und sollst ihn überziehen mit feinem Gold und einen goldenen Kranz umher machen

25 und eine Leiste umher, eine Handbreit hoch, und einen goldenen Kranz um die Leiste her.

26 Und sollst vier goldene Ringe daran machen an die vier Ecken an seinen vier Füßen.

27 Hart unter der Leiste sollen die Ringe sein, daß man Stangen darein tue und den Tisch trage.

28 Und sollst die Stangen von Akazienholz machen und sie mit Gold überziehen, daß der Tisch damit getragen werde.

29 Du sollst auch aus feinem Golde seine Schüsseln und Löffel machen, seine Kannen und Schalen, darin man das Trankopfer darbringe.

30 Und sollst auf den Tisch allezeit Schaubrote legen vor mir.

31 Du sollst auch einen Leuchter von feinem, getriebenem Golde machen; daran soll der Schaft mit Röhren, Schalen, Knäufen und Blumen sein.

32 Sechs Röhren sollen aus dem Leuchter zu den Seiten ausgehen, aus jeglicher Seite drei Röhren.

33 Eine jegliche Röhre soll drei offene Schalen mit Knäufen und Blumen haben; so soll es sein bei den sechs Röhren aus dem Leuchter.

34 Aber der Schaft am Leuchter soll vier offene Schalen mit Knäufen und Blumen haben

35 und je einen Knäuf unter zwei von den Sechs Röhren, welche aus dem Leuchter gehen.

36 Beide, die Knäufe und Röhren, sollen aus ihm gehen, alles getriebenes, lauterer Gold.

37 Und sollst sieben Lampen machen obenauf, daß sie nach vornehin leuchten,

38 und Lichtschneuzen und Löschnäpfe von feinem Golde.

39 Aus einem Zentner feinen Goldes sollst du das machen mit allem diesem Gerät.

40 Und siehe zu, daß du es machst nach dem Bilde, das du auf dem Berge gesehen hast.

Luther Bibel 1545 (LUTH1545)

Copyright © 1545 by [Public Domain](#)

Picture Sources

- p. 2 Mountain background. Clipartpanda.com Gossip Man walking away: <http://cliparts.co>
- p. 3 Mountain background. Man walking away: same as above. Man with handcuff and two others: http://www.clipartpanda.com/clipart_images/man-with-handcuff-black-vector-55984142. Judge: http://www.clipartpanda.com/clipart_images/18-judge-clipart-6645317
- p. 4 Mountain background. Man walking away: same as above. Crowd: http://www.clipartpanda.com/clipart_images/downloads-6896946
- p. 5 Mountain background. Man walking away: same as above. http://www.clipartpanda.com/clipart_images/god-has-blessed-us-with-an-7116334.
- p. 6 Mountain background. Blind Justice: <http://cliparts.co/clipart/77646> Poor man: <http://www.itimes.com/photo/poor-people-clipart-clipart-panda-free-clipart-images> rich man: http://www.clipartpanda.com/clipart_images/free-vector-rich-man-clip-art-3844706

112

Picture Sources (Continued)

- p. 10 Mountain background. bad judge: http://www.clipartpanda.com/clipart_images/judge-makes-verdict-51332544 Emoticons white one with added halo, and yellow one in bottom right corner. <http://beelikeable.blogspot.com/> Red thunder bolt. <http://www.clipartpanda.com/categories/red-lightning-bolt-clipart>.
- p. 11 Mountain background. Money bag as above. Good Judge with hand modified to refuse the money: http://www.clipartpanda.com/clipart_images/18-judge-clipart-6645317.
- p. 12 Mountain background. Man walking away remembering Egypt: Oppression of Egypt: freebibleimages.org/05_Moses_Pharaoh_JPEG_1024 Mean boss: http://www.clipartpanda.com/clipart_images/boss-clip-art-images-8500849 Blue stranger: <https://www.behance.net/gallery/Stickers-For-Facebook-Messenger/10890693>

114

Picture Sources (Continued)

- p. 7 Mountain background. Ox from <https://openclipart.org/detail/9004/ox> Donkey with rope: <http://www.clker.com/cliparts/a/4/f/1/13316594631778733765Donkey%20with%20a%20Load.svg.med.png> House: http://www.clipartpanda.com/clipart_images/downloads-1490530 Men shaking hands: <https://openclipart.org/detail/201468/men-shacking-hand-4-differents-versions>
- p. 8 Mountain background. http://www.123rf.com/photo.8464355_the-donkey-carries-a-large-bag.html?term=donkey%20burden Copyright:http://www.123rf.com/profile_dedmazay/ 123RF Stock Photo. Gray standing donkey: <http://www.clipartlord.com/wp-content/uploads/2014/07/donkey6.png>
- p. 9 Mountain background. Blind Justice: <http://cliparts.co/clipart/77646> rich man: http://www.clipartpanda.com/clipart_images/free-vector-rich-man-clip-art-3844706 Poor man: <http://www.itimes.com/photo/poor-people-clipart-clipart-panda-free-clipart-images>

113

Picture Sources (Continued)

- p. 13 Mountain background Clipart 6: http://www.clipartpanda.com/clipart_images/number-clip-art-for-kids-and-30537309 Calendar: http://www.clipartpanda.com/clipart_images/are-turning-to-next-year-57179736 Farmer on tractor: http://www.clipartpanda.com/clipart_images/tractor-clip-art-vector-43689659 Produce stand: http://www.clipartpanda.com/clipart_images/local-community-market-16999824
- p. 14 Mountain background. Clipart 7: http://www.clipartpanda.com/clipart_images/number-7-purple-circle-clip-1546820 Calendar: same as above: Empty tractor: http://www.clipartpanda.com/clipart_images/tractor-clip-art-images-stock-43689456 Gleaner: <http://cdn.www.ministry-to-children.com/wp-content/uploads/2011/03/ruth-coloring-page.jpg>
- p. 15 Mountain background. Calendar and wheat as above. farm animals: http://www.clipartpanda.com/clipart_images/cute-farm-clip-art-46213054
- p. 16 Mountain background. other items as in previous pictures. grapes: http://www.clipartpanda.com/clipart_images/clip-art-grapes-viewing-39416914 Olives: http://www.clipartpanda.com/clipart_images/the-olive-tree-clip-art-20459023

115

Picture Sources (Continued)

- p. 17 Mountain background same as above. Sun: http://www.clipartpanda.com/clipart_images/clipart-graphics-available-15780309
- p. 18 Number 7: same as above. Sun/moon: same as above. Man resting: http://www.clipartpanda.com/clipart_images/home-in-the-afternoon-7414438
- p. 19 Ox and donkey: Family holding hands: http://www.clipartpanda.com/clipart_images/extended-period-of-time-6945446 same as above man resting: http://familyandfriends.phillipmartin.info/friends_chillin.htm Blue stranger: One resting.
- p. 20 Mountain background Girl: <http://www.mycutegraphics.com/graphics/kids/quiet-girl.html>

116

Picture Sources (Continued)

- p. 26 Mountain background. Man walking away: same as above stone alter: <http://www.freechristianillustrations.com/Clipart%20Altar%20BW.pdf> Leavened bread. Same as above
- p. 27 Mountain background Man walking away: same as above, but modified to be carrying away the morning. Stone alter: same as above 17. Sunrise: <http://www.publicdomainpictures.net/view-image.php?image=71180&picture=sunrise-over-green-hills> Steak: <http://cliparts.co/clipart/2971125>
- p. 28 Mountain background. www-St-Takla-org-a-thank-offering-to-god
- p. 29 Mountain background and man walking as before. Mother goat: http://www.clipartpanda.com/clipart_images/goats-clip-art-2980736 Baby goat: http://animals.phillipmartin.info/animal-goat_m.htm cauldron: http://www.clipartpanda.com/clipart_images/cauldron-clipart-image-54761134

118

Picture Sources (Continued)

- p. 21 Mountain background Campmeeting: "Methodist camp meeting (1819 engraving)" by Jacques Gérard Milbert (1766-1840) - Library of Congress, Prints and Photographs Division (LC-USZ62-2497). Licensed under Public Domain via Wikimedia Commons - [https://commons.wikimedia.org/wiki/File:Methodist_camp_meeting_\(1819_engraving\).jpg#/media/File:Methodist_camp_meeting_\(1819_engraving\).jpg](https://commons.wikimedia.org/wiki/File:Methodist_camp_meeting_(1819_engraving).jpg#/media/File:Methodist_camp_meeting_(1819_engraving).jpg) Our photograph of newly formed wheat heads. Leavened bread: http://www.clipartpanda.com/clipart_images/loaf-of-bread-clip-art-804314 Unleavened bread: our picture. cornucopia: http://www.clipartpanda.com/clipart_images/expect-to-write-better-1807756
- p. 22 Mountain background Abib month picture, Eating unleavened bread.
- p. 23 Mountain background Picture of Bill and boys and loaves of bread
- p. 24 Mountain background Tent and fixing food
- p. 25 Mountain background conglomerate of last three pictures

117

Picture Sources (Continued)

- p. 30 Mountain background. Angel before Israelites Jesus leading: sheep-following from <http://christianchat.com/bible-discussion-forum/108896-life-sheep-know-my-sheep-am-known-mine-john-10-14-a.html> and Jordan crossing: [www-St-Takla-org—Bible-Slides-joshua-513](http://www-St-Takla-org-Bible-Slides-joshua-513)
- p. 31 Mountain background. mother and child: http://www.clipartpanda.com/clipart_images/obedient-carto-52047754
- p. 32 Mountain background. Jesus heals paralytic C-42 from Ultimate Bible Picture Collection
- p. 33 Mountain background. Jesus and Bible: <http://ubdavid.org/youthworld/countryheaven/country-heaven4.html> Heart with children: http://www.clipartpanda.com/clipart_images/writing-at-public-discourse-14004908
- p. 34 Mountain background. Angel with Joshua: <https://www.lds.org/manual/old-testament-stories/chapter-23-joshua?lang=eng> Jesus with white horse: <http://simplyheavenlyfood.tumblr.com/post/34682419364/joshua-5-13-now-it-came-about-when-joshua-was-by>

119

Picture Sources (Continued)

- p. 35 Mountain background. Angel with Joshua: <http://www.bibleprobe.com/Joshuaangel.jpg>
- p. 36 Mountain background. Gideon destroying baal's altar BBL99-11 Ultimate Bible Picture Collection
- p. 37 Mountain background. People in church: http://www.clipartpanda.com/clipart_images/church-clip-art-1274717 Field with food: [http://108.167.180.60/dcastel/free clipart source water](http://108.167.180.60/dcastel/free_clipart_source_water): http://www.clipartpanda.com/clipart_images/water-clip-art-22-37686049
- p. 38 Mountain background. sick child: http://www.clipartpanda.com/clipart_images/sick-clip-art-22099023 Healthy child: http://www.clipartpanda.com/clipart_images/emotional-health-clip-art-3212304
- p. 39 Mountain background. Single sheep: <http://animals.phillipmartin.info/sheep03.htm> Pregnant woman: http://www.clipartpanda.com/clipart_images/pregnancy-clip-art-4792922 Pregnant woman with child silhouette: http://www.clipartpanda.com/clipart_images/pregnant-clip-art-4791621 Lambs: http://animals.phillipmartin.info/animal_sheep.htm

120

Picture Sources (Continued)

- p. 45 Mountain background Map of fertile crescent adjusted to show land in Ex. 23:31 : "Map of fertile crescent" by Nafsadh - Map of fertile crescent.png. Licensed under GFDL via Wikimedia Commons - https://commons.wikimedia.org/wiki/File:Map_of_fertile_crescent.svg#/media/File:Map_of_fertile_crescent.svg
- p. 46 Mountain background Man walking away as before. alter as before. Men shaking hands: http://www.clipartpanda.com/clipart_images/handshake-of-business-people-39389901
- p. 47 Mountain background Trap: <file:///C:/Users/hh2/Downloads/trap-clipart-trap-snare-of-adversary-c.gif>
- p. 48 Glory Halo. Elders coming up: same as E2409
- p. 49 Glory Halo. TheGloryStory.com Moses 2 22 Picture used with permission: (c)2006 www.TheGloryStory.com
- p. 50 freebibleimages.org 26_Moses_Sinai_JPEG.1024, focus on Moses
- p. 51 freebibleimages.org 26_Moses_Sinai_JPEG.1024, focus on people
- p. 52 freebibleimages.org 12_Moses_Amalekites_JPEG.1024

122

Picture Sources (Continued)

- p. 40 Mountain background. Old people with barbells: http://www.clipartpanda.com/clipart_images/14-186-old-people-clip-art-2361937 Old Couple: http://www.clipartpanda.com/clipart_images/old-people-clip-art-52443731
- p. 41 freebibleimages.org 13_Joshua_Rahab_Spies: freebibleimages.org 04_Abraham_Promise_JPEG.1024
- p. 42 Mountain background. single hornet: http://www.clipartpanda.com/clipart_images/bee-hornet-graphic-vector-3310610 Bee swarm: http://www.clipartpanda.com/clipart_images/bee-swarm-25744437 Bee with hive: http://www.clipartpanda.com/clipart_images/clip-art-25746104
- p. 43 Mountain background Wheel in desolate place: http://files.all-free-download.com/free_download_graphic_272495.html Lion: <http://i1198.photobucket.com/albums/aa454/Prabir-2010/Lion-2.jpg>
- p. 44 Mountain background. Jericho: freebibleimages.org 10_Joshua_Jericho cloud around it.

121

Picture Sources (Continued)

- p. 53 <http://www.accordingtothescrptures.org/doctrine/redseacrossing.html>
- p. 54 <https://www.gci.org/law/sct02>
- p. 55 <http://thewholebook.blogspot.com/2015/04/192-sprinkling.html>
- p. 56 freebibleimages.org 28_Moses_Sinai_JPEG.1024 focus on Moses
- p. 57 freebibleimages.org 28_Moses_Sinai_JPEG.1024 focus on People
- p. 58 visualbiblealive.com 110_06_0173_BiblePaintings
- p. 59 freebibleimages.org 30_Moses_Sinai_JPEG.1024
- p. 60 Sapphire gem: <http://www.gia.edu/sapphire> Sapphire rutile streaks: <http://www.gia.edu/sapphire-quality-factor>
- p. 61 http://allacin.blogspot.com/2014.08.01_archive.html
- p. 62 Glory Halo: Ultimate Bible Collection Mos&10 Commandments 46-1177-b
- p. 63 <http://www.swordofthespirit.net/bulwark/february2012p4.htm>
- p. 64 freebibleimages.org 03_Moses_Sinai_JPEG.1024

123

Picture Sources (Continued)

- p. 65 TheGloryStory.com Moses 2 22 Picture used with permission: (c)2006 www.TheGloryStory.com
- p. 66 the Providence Lithograph Company - <http://thebiblerevival.com/clipart/1907/ex20-1.jpg>
- p. 67 TheGloryStory.com Moses 2 21 Picture used with permission: (c)2006 www.TheGloryStory.com
- p. 68 public domain
- p. 69 <http://www.rgbstock.com/bigphoto/mfqFRqe> by mckenna71
- p. 70 Mountain background. [www-St-Takla-org-Bible-Slides-exodus-431\(1\)](http://www-St-Takla-org-Bible-Slides-exodus-431(1))
- p. 71 Mountain background. Coins: <http://www.coinnews.net/2013/06/19/miss-canada-allegory-in-gold-silver-and-bronze-coins/>
- p. 72 Mountain background with our own photograph.

124

Picture Sources (Continued)

- p. 76 Mountain background, Moses seeing Tabernacle from the mountain: http://www.visualbiblealive.com/image_download.php?image_id=75762&type=mm
- p. 77 Mountain background with <http://orion.it.luc.edu/avande1/jerusalem/views/tabernacleLayout.htm> All dimensions are in cubits. 1 cubit = 1 royal cubit = 20.67 inches.
- p. 78 Mountain background. exploded diagram of ark of covenant from <http://thedeserttabernacle.blogspot.com/2011/01/exodus-2510-22-exploded-diagram-of-ark.html> acacia tree: <http://i186.photobucket.com/albums/x128/sleemon/Niger%20Part%201/06Marche44.jpg>
- p. 79 Mountain background. exploded diagram of ark of covenant. Gold leaf overlay: "Small gold nugget 5mm dia and corresponding foil surface of half sq meter" by PHGCOM - Own work by uploader, Toi gold mine. Licensed under CC BY-SA 3.0 via Wikimedia Commons - https://commons.wikimedia.org/wiki/File:Small_gold_nugget_5mm_dia_and_corresponding_foil_surface_of_half_sq_meter.jpg#/media/File:Small_gold_nugget_5mm_dia_and_corresponding_foil_surface_of_half_sq_meter.jpg

126

Picture Sources (Continued)

- p. 73 Mountain background. Red skins: Copyright Dainis Derics @123rf.com Used by permission. Badger: <http://i417.photobucket.com/albums/pp258/airdjinn/badger.jpg> acacia wood: tree: <http://i186.photobucket.com/albums/x128/sleemon/Niger%20Part%201/06Marche44.jpg> flooring: <http://www.ablaabla.com/acacia-wood-flooring/>. Goat as before in used in Exodus 23:19
- p. 74 Mountain background My picture of some of the spices.
- p. 75 Mountain background black onyx: "Black Onyx" by The original uploader was Grandor at English Wikipedia - Transferred from en.wikipedia to Commons.. Licensed under CC BY-SA 3.0 via Wikimedia Commons - https://commons.wikimedia.org/wiki/File:Black_Onyx.jpg#/media/File:Black_Onyx.jpg "Gem.pebbles.800pix .labelled" by Original uploader was Arpingstone - Transferred from en.wikipedia to Commons.. Licensed under Public Domain via Wikimedia Commons - <https://commons.wikimedia.org/wiki/File:Gem.pebbles.800pix.labelled.jpg#/media/File:Gem.pebbles.800pix.labelled.jpg> Note: not all these pictured were in the ephod

125

Picture Sources (Continued)

- p. 80 Mountain background. exploded diagram of ark of covenant, focus on crown molding. Gold bars: "400-oz-Gold-Bars-AB-01" by Andrzej Barabasz (Chepyr) - Own work. Licensed under CC BY-SA 4.0 via Wikimedia Commons - <https://commons.wikimedia.org/wiki/File:400-oz-Gold-Bars-AB-01.jpg#/media/File:400-oz-Gold-Bars-AB-01.jpg>
- p. 81 Mountain background. exploded diagram of ark of covenant, with focus on of the 4 rings to put in the corners. Gold bars as above.
- p. 82 Mountain background. exploded diagram of ark, focus on poles. Picture with gold leaf
- p. 83 Mountain background. <http://thedeserttabernacle.blogspot.com> Tabernacle+Mishkan+Ark+of+the+Covenant+Diagram+Four+Legs+Footings++View+3.jpg with focus on poles and rings.
- p. 84 Mountain background. Ten Commandments: <http://thedeserttabernacle.blogspot.com/2010/01/exodus-2510-22-ark-of-covenant-heart-of.html> Put on image: Aleksandr Sigalov thedeserttabernacle.blogspot.com
- p. 85 Mountain background. exploded ark diagram, focus on the mercey seat. Gold bar.

127

Picture Sources (Continued)

- p. 86 Mountain background. exploded ark diagram, focus on cherubim. Beating Gold: "Fotothek df tg 0008550-ext" by Fotothek_df.tg.0008550_Ständebuch_ ^_Beruf_ ^_Handwerk_ ^_Goldschmied_ ^_Blattgold.jpg: Christoph Weigelderivative work: Wizard191 (talk) - Fotothek_df.tg.0008550_Ständebuch_ ^_Beruf_ ^_Handwerk_ ^_Goldschmied_ ^_Blattgold.jpg. Licensed under Public Domain via Wikimedia Commons - https://commons.wikimedia.org/wiki/File:Fotothek_df.tg.0008550-ext.jpg#/media/File:Fotothek_df.tg.0008550-ext.jpg Beaten Gold ring: <https://www.etsy.com/listing/28625719/hammered-gold-disc-ring-with-a-czE>
- p. 87 Mountain background. ark diagram from <http://sickleoftruth.com/> focus on cherubim at ends of ark, and mercy seat
- p. 88 Mountain background. ark diagram from <http://sickleoftruth.com/>, focus the cherubim's wings
- p. 89 Mountain background. ark from <http://sickleoftruth.com/> Ten Commandments inside.
- p. 90 Mountain background. ark from <http://sickleoftruth.com/> and Glory resting between the cherubim.

128

Picture Sources (Continued)

- p. 95 Exploded diagram above, focus on molding. and gold bars.
- p. 96 Exploded diagram of shewbread table above, focus on four rings. and gold bars.
- p. 97 Exploded diagram of shewbread table above, focus on poles. Acacia wood, gold overlay.
- p. 98 Exploded diagram of shewbread table above, focus on dishes and pans, etc. Gold bars.
- p. 99 Exploded diagram of shewbread table above, focus on bread

130

Picture Sources (Continued)

- p. 91 Mountain background, Tabernacle blueprint above, focus on dimensions of shewbread table. Picture of acacia tree:
- p. 92 Table of show bread <http://thedeserttabernacle.blogspot.com/2011/02/exodus-2525-enclosure-border-of-table.html> Tabernacle Mishkan Table of Shewbread Diagram Gray - View 1 thedeserttabernacle.blogspot.com; Gold leaf overlay: "Small gold nugget 5mm dia and corresponding foil surface of half sq meter" by PHGCOM - Own work by uploader, Toi gold mine. Licensed under CC BY-SA 3.0 via Wikimedia Commons - https://commons.wikimedia.org/wiki/File:Small_gold_nugget_5mm_dia_and_corresponding_foil_surface_of_half_sq_meter.jpg#/media/File:Small_gold_nugget_5mm_dia_and_corresponding_foil_surface_of_half_sq_meter.jpg
- p. 93 Exploded diagram above, focus on molding. and gold bars.
- p. 94 Exploded diagram above, focus on molding. Closer view of bottom shelf: <http://thedeserttabernacle.blogspot.com/2011/02/exodus-2525-enclosure-border-of-table.html> and gold bars.

129

Picture Sources (Continued)

- p. 100 Exploded diagram: of lampstand http://1.bp.blogspot.com/_..nlF5GEQX5M/TT8LG2baF6I/AAAAAAAAADss/D0zH3b30T4Q/s1600/Tabernacle+Mishkan+Candlestick+Lampstand+Menorah+Diagram+Gray+-+View+1.jpg from Aleksandr Sigalov thedeserttabernacle.blogspot.com Beating Gold: "Fotothek df tg 0008550-ext" by Fotothek_df.tg.0008550_Ständebuch_ ^_Beruf_ ^_Handwerk_ ^_Goldschmied_ ^_Blattgold.jpg: Christoph Weigelderivative work: Wizard191 (talk) - Fotothek_df.tg.0008550_Ständebuch_ ^_Beruf_ ^_Handwerk_ ^_Goldschmied_ ^_Blattgold.jpg. Licensed under Public Domain via Wikimedia Commons - https://commons.wikimedia.org/wiki/File:Fotothek_df.tg.0008550-ext.jpg#/media/File:Fotothek_df.tg.0008550-ext.jpg Beaten Gold ring: <https://www.etsy.com/listing/28625719/hammered-gold-disc-ring-with-a-czE>
- p. 101 Tabernacle - Mishkan - Exodus 37-17-24 - Lampstand Schematic Diagram - View 1 from <http://thedeserttabernacle.blogspot.com>
- p. 102 Colored lampstand picture above, focus on the branches.

131

Picture Sources (Continued)

- p. 103 Colored lampstand picture above, focus on bowls on the branches (not the middle ones.)
- p. 104 Colored lampstand picture above, focus on bowls in the middle
- p. 105 Colored lampstand picture above, focus on the knops
- p. 106 colored lampstand picture above, focus on knops integrated in with the branches
- p. 107 colored lampstand picture above, focus on seven lamps
- p. 108 Exploded lampstand diagram above, focus on wick trimmers and accessories, gold bars from above.
- p. 109 Gold bar in hand:http://us.wow.com/wiki/Good_Delivery?s_pt=aolsem&s_chn=158 Talent measure: https://en.wikipedia.org/wiki/Talent_%28measurement%29 Pattern: as above.